

**ORTHOPEDIC SURGERY
INSTRUMENT SETS**

Product Catalogue

quality & trust

aysam.com.tr



OUR VISION IS TO BE THE LEADING COMPANY WORLD WIDE IN ORTHOPAEDIC DEVICES AND SURGICAL INSTRUMENTS WITH SUSTAINABLE GROWTH, BY FOLLOWING "CONTINUOUS IMPROVEMENT" AND "QUALITY IS IN DETAILS" PRINCIPLE.

Aysam has adopted the Total Quality Management System beginning from raw materials to the end of sales services. With this understanding it has certified its quality with certificates such as **CE , ISO 9001, ISO 13485.**

Aysam aims to ensure the continuity of customer, patient and physician satisfaction in all conditions by educating and informing its staff at an advanced level in order to respond to requests from its customers faster and with higher quality. It increases its individual and institutional quality by updating it with continuous trainings and seminars.

Aysam continues to add new products to its **17344 product** range with R&D studies. It combines its 20 years of knowledge with modern technology and produces its products in a more innovative and qualified way.



aysam

f aysam.orthopedics

t aysamortho

in aysam

YouTube aysam orthopaedics

Instagram aysamorthopaedics

With its customer feedbacks, R&D studies, specialist physicians, experienced engineers and modern infrastructure compatible with the requirements of the age, Aysam has adopted high quality, improved and innovative production as its principle.

With export to five continents for 20 years, Aysam is increasing its number of distributors day by day and advancing its goals with firm steps. Aysam continues its activities in full harmony and loyalty with its dealers and distributor companies & participates in the national, international fairs and congresses and introduces its products that it offers to the service of the Medical World.

Aysam is rapidly approaching its goals with its understanding of service that does not compromise on patient, physician and health personnel health, customer satisfaction and quality, and with its structure open to innovations.

QUALITY

We produce best quality products according to ISO 13485/MDD.

TRUST

We always support our customers and distributors in the market.

EXPERIENCE

Aysam has over 20 years experience on surgery instrument set production.

INNOVATION

Innovation is our indispensable condition to move forward.



“We supply WORLD’s
Surgery Instrument
Sets...”





INDEX

- **SMALL FRAGMENT LOCKING / NON-LOCKING PLATE INSTRUMENT SET6**
- **LARGE FRAGMENT LOCKING / NON-LOCKING PLATE INSTRUMENT SET.....6**
- **DHS & DCS INSTRUMENT SET7**
- **FLEXIBLE REAMER SURGERY INSTRUMENT SET8**
- **PELVIC RECONSTRUCTION PLATE INSTRUMENT SET.....8**
- **MICRO PLATE INSTRUMENT SET.....9**
- **MINI FRAGMENT PLATE INSTRUMENT SET.....9**
- **1,5/2,0 MM MAXILLOFACIAL PLATE INSTRUMENT SET10**
- **2,4 MM MAXILLOFACIAL PLATE INSTRUMENT SET10**
- **STERNUM RIB PLATE INSTRUMENT SET.....11**
- **3,5/4,5 MM ANGLED BLADE PLATE INSTRUMENT SET11**
- **2,7-3,5-4,0 MM CANNULATED SCREW INSTRUMENT SET12**
- **4,5-6,5-7,3 MM CANNULATED SCREW INSTRUMENT SET12**
- **PIN-WIRE INSTRUMENT SET.....13**
- **SCREW REMOVAL INSTRUMENT SET.....13**
- **HERBERT CANNULATED SCREW INSTRUMENT SET.....14**
- **HUMERAL INTRAMEDULLARY NAIL INSTRUMENT SET.....14**
- **FEMUR ANTEGRADE INTRAMEDULLARY NAIL INSTRUMENT SET.....15**
- **DISTAL FEMUR RETROGRADE & SHORT R PFN INTRAMEDULLARY NAIL INSTRUMENT SET15**
- **NEW FEMORAL RECONSTRUCTION INTRAMEDULLARY NAIL INSTRUMENT SET.....16**
- **APFNA FEMUR SHORT NAIL INSTRUMENT SET.....17**
- **ANT TIBIAL INTRAMEDULLARY NAIL INSTRUMENT SET.....18**
- **TIBIAL INTRAMEDULLARY NAIL INSTRUMENT SET.....19**
- **INTRAMEDULLARY NAIL REMOVAL INSTRUMENT SET.....20**
- **ELASTIC NAIL INSTRUMENT SET.....20**
- **SPINAL PEDICLE SCREW SYSTEM INSTRUMENT SET.....21**
- **ANTERIOR CERVICAL PLATE SYSTEM INSTRUMENT SET.....21**
- **POSTERIOR CERVICAL FIXATION SYSTEM INSTRUMENT SET.....22**
- **ANTERIOR THORACIC & LUMBAR PLATE SYSTEM INSTRUMENT SET.....22**
- **AYFIX EXTERNAL FIXATOR INSTRUMENT SET.....23**
- **MINI RAIL EXTERNAL FIXATOR INSTRUMENT SET.....23**
- **TUBULAR EXTERNAL FIXATOR INSTRUMENT SET.....24**
- **HYBRID EXTERNAL FIXATOR INSTRUMENT SET.....24**
- **ILIZAROV CIRCULAR EXTERNAL FIXATOR INSTRUMENT SET.....25**
- **PEDIATRIC ILIZAROV CIRCULAR EXTERNAL FIXATOR INSTRUMENT SET.....25**
- **3,0/3,5/4,0/5,0/6,5 MM HEADLESS COMPRESSION SCREW INSTRUMENT SET.....26**
- **3,0/3,5/4,0 MM HEADLESS COMPRESSION SCREW INSTRUMENT SET.....26**
- **5,0/6,5 MM HEADLESS COMPRESSION SCREW INSTRUMENT SET.....27**
- **CABLE INSTRUMENT SET.....27**

ORTHOPAEDIC SURGERY INSTRUMENT SETS

SMALL FRAGMENT LOCKING / NON-LOCKING PLATE INSTRUMENT SET

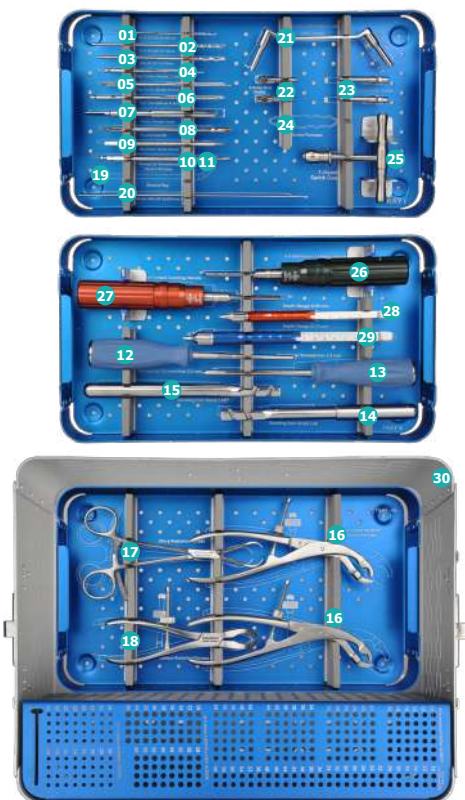

A3200-0100

- A3200-0101 DRILL BIT Ø2,0X110 MM
- A3200-0102 DRILL BIT Ø2,7X130 MM
- A3200-0103 DRILL BIT Ø3,2X130 MM
- A3200-0104 TAP FOR CORTEX SCREW 2,7 MM
- A3200-0105 TAP FOR CORTEX SCREW 3,5 MM
- A3200-0106 TAP CANCELLOUS 4,0 MM
- A3200-0107 HOLLOW REAMER SMALL
- A3200-0108 COUNTERSINK Ø6,0
- A3200-0109 EXTRACTION SCREW HEXAGONAL 2,5 MM CONICAL
- A3200-0110 HEXAGONAL SCREWDRIVER SHAFT 2,0 MM QUICK COUPLING
- A3200-0111 HEXAGONAL SCREWDRIVER SHAFT 2,5 MM QUICK COUPLING
- A3200-0112 HEXAGONAL SCREWDRIVER 2,0 MM
- A3200-0113 HEXAGONAL SCREWDRIVER 2,5 MM
- A3200-0114 BENDING IRON SMALL RIGHT
- A3200-0115 BENDING IRON SMALL LEFT
- A3200-0116 SELF-CENTERING BONE HOLDING FORCEPS (190 MM)
- A3200-0117 SHARP REDUCTION FORCEP (170 MM)
- A3200-0118 OBLIQUE REDUCTION FORCEP (190 MM)
- A3200-0119 SLEEVE KEY
- A3200-0120 GUIDE WIRE Ø1,8X200 MM
- A3200-0121 NEUTRAL AND LOAD DRILL GUIDE
- A3200-0122 THREADED DRILL GUIDE (SLEEVE) 2,0 MM
- A3200-0123 THREADED DRILL GUIDE (SLEEVE) 2,7 MM
- A3200-0124 SCREW FORCEPS
- A3200-0125 T-HANDLE QUICK COUPLING
- A3200-0126 TORQUE LIMITING HANDLE 0,8 NM
- A3200-0127 TORQUE LIMITING HANDLE 1,5 NM
- A3200-0128 DEPTH GAUGE 0-50 MM
- A3200-0129 DEPTH GAUGE 0-70 MM
- A3200-0130 ALUMINIUM BOX

LARGE FRAGMENT LOCKING / NON-LOCKING PLATE INSTRUMENT SET

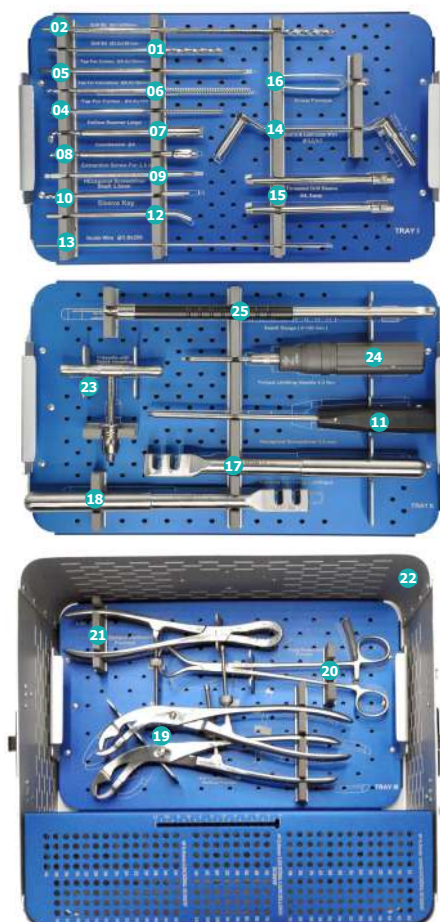

A3200-0200

- A3200-0201 DRILL BIT Ø3,2X150 MM
- A3200-0202 DRILL BIT Ø4,1X250 MM
- A3200-0204 TAP FOR CORTEX SCREW 4,5 MM
- A3200-0205 TAP FOR CORTEX SCREW 5,0 MM
- A3200-0206 TAP CANCELLOUS 5,0 MM
- A3200-0207 HOLLOW REAMER LARGE
- A3200-0208 COUNTERSINK Ø8,0
- A3200-0209 EXTRACTION SCREW HEXAGONAL 3,5 MM CONICAL
- A3200-0210 HEXAGONAL SCREWDRIVER SHAFT 3,5 MM QUICK COUPLING
- A3200-0211 HEXAGONAL SCREWDRIVER 3,5 MM
- A3200-0212 SLEEVE KEY
- A3200-0213 GUIDE WIRE Ø1,8X250 MM
- A3200-0214 NEUTRAL AND LOAD DRILL GUIDE 3,2/4,5 MM
- A3200-0215 THREADED DRILL GUIDE (SLEEVE) 4,1 MM
- A3200-0216 SCREW FORCEPS
- A3200-0217 BENDING IRON LARGE RIGHT
- A3200-0218 BENDING IRON LARGE LEFT
- A3200-0219 SELF-CENTERING BONE HOLDING FORCEPS (270 MM)
- A3200-0220 SHARP REDUCTION FORCEP (200 MM)
- A3200-0221 OBLIQUE REDUCTION FORCEP (230 MM)
- A3200-0222 ALUMINIUM BOX
- A3200-0223 T-HANDLE QUICK COUPLING
- A3200-0224 TORQUE LIMITING HANDLE 4,0 NM
- A3200-0225 DEPTH GAUGE 0-120 MM
- A3200-0226 THREADED DRILL GUIDE (SLEEVE) 4,5 MM

ORTHOPAEDIC SURGERY INSTRUMENT SETS

DHS & DCS INSTRUMENT SET

A4200-0500

- DHS & DCS INSTRUMENT SET**
- A4200-0501 T-HANDLE QUICK COUPLING
 - A4200-0502 TAP CORTEX SCREW 4,5 MM
 - A4200-0503 TAP CORTEX SCREW 5,0 MM
 - A4200-0504 SIMPLE DRILL CLIP
 - A4200-0505 NEUTRAL AND LOAD DRILL GUIDE 3,2-4,5 MM
 - A4200-0506 HEXAGONAL SCREWDRIVER SW 3,5 MM WITH QUICK COUPLING
 - A4200-0507 DRILL BIT Ø4,1X250 MM
 - A4200-0508 DRILL BIT Ø3,2X150 MM
 - A4200-0509 LAG SCREW DEPTH MEASURING DEVICE
 - A4200-0510 TAP FOR LAG SCREW
 - A4200-0511 THREADED K-WIRE Ø1,8X230 MM
 - A4200-0512 DHS/DCS IMPACTOR LARGE
 - A4200-0513 DEPTH GAUGE 0-120 MM
 - A4200-0514 DHS/DCS IMPACTOR SMALL
 - A4200-0515 DHS/DCS WRENCH 2
 - A4200-0516 DHS/DCS WRENCH 1
 - A4200-0517 HEXAGONAL SCREWDRIVER SW 3,5 MM
 - A4200-0518 DCS ANGLE GUIDE 95°
 - A4200-0519 DHS ANGLE GUIDE 135°
 - A4200-0520 DHS REAMER
 - A4200-0521 DCS REAMER
 - A4200-0522 ALUMINIUM BOX
 - A4200-0523 SCREW FORCEPS
 - A4200-0524 THREADED DRILL GUIDE(SLEEVE) 4,1 MM

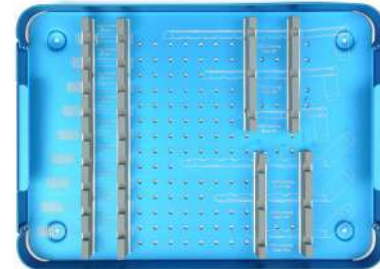
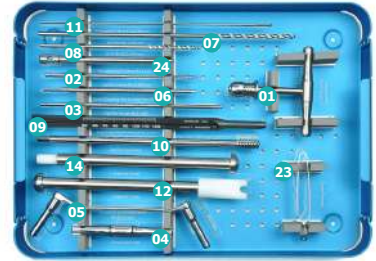

DHS & DCS
INSTRUMENT SET



LARGE FRAGMENT LOCKING / NON-LOCKING
PLATE INSTRUMENT SET



SMALL FRAGMENT LOCKING / NON-LOCKING
PLATE INSTRUMENT SET



ORTHOPAEDIC SURGERY INSTRUMENT SETS

FLEXIBLE REAMER SURGERY INSTRUMENT SET

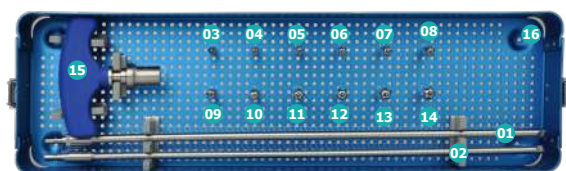

A5201-0100

- A5201-0101 FLEXIBLE REAMER Ø7,5 MM
- A5201-0102 FLEXIBLE REAMER Ø8,0 MM
- A5201-0103 FLEXIBLE REAMER BIT Ø7,5 MM
- A5201-0104 FLEXIBLE REAMER BIT Ø8,0 MM
- A5201-0105 FLEXIBLE REAMER BIT Ø8,5 MM
- A5201-0106 FLEXIBLE REAMER BIT Ø9,0 MM
- A5201-0107 FLEXIBLE REAMER BIT Ø9,5 MM
- A5201-0108 FLEXIBLE REAMER BIT Ø10 MM
- A5201-0109 FLEXIBLE REAMER BIT Ø10,5 MM
- A5201-0110 FLEXIBLE REAMER BIT Ø11 MM
- A5201-0111 FLEXIBLE REAMER BIT Ø11,5 MM
- A5201-0112 FLEXIBLE REAMER BIT Ø12 MM
- A5201-0113 FLEXIBLE REAMER BIT Ø12,5 MM
- A5201-0114 FLEXIBLE REAMER BIT Ø13 MM
- A5201-0115 T-HANDLE WITH QUICK COUPLING
- A5201-0116 ALUMINIUM BOX

FLEXIBLE REAMER SURGERY INSTRUMENT SET

PELVIC RECONSTRUCTION PLATE INSTRUMENT SET

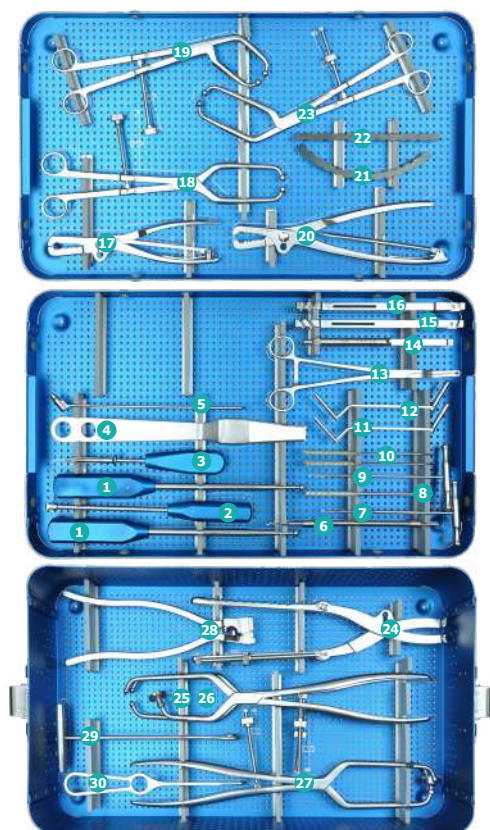

A4200-0800

- A4200-0801 STRAIGHT BALL SPIKE 300 MM
- A4200-0802 UNIVERSAL HEXAGONAL SCREWDRIVER SW 2,5
- A4200-0803 HEXAGONAL SCREWDRIVER SW 2,5
- A4200-0804 RETRACTOR
- A4200-0805 DRILL GUIDER Ø2,5 MM
- A4200-0806 FLEXIBLE DRILL BIT Ø2,5 MM
- A4200-0807 TAP Ø3,5 MM
- A4200-0808 DRILL BIT Ø3,0 MM
- A4200-0809 TAP Ø4,0 MM
- A4200-0810 DRILL BIT Ø2,5 MM
- A4200-0811 DRILL-TAP GUIDER Ø2,5-Ø3,5 MM
- A4200-0812 DRILL-TAP GUIDER Ø3,0-Ø4,0 MM
- A4200-0813 SCREW HOLDER FORCEP
- A4200-0814 DEPTH GAUGE 0-70 MM
- A4200-0815 BENDING IRON LEFT
- A4200-0816 BENDING IRON RIGHT
- A4200-0817 BONE HOLDING FORCEP 200 MM
- A4200-0818 REDUCTION FORCEP STRAIGHT
- A4200-0819 REDUCTION FORCEP CURVED 250 MM
- A4200-0820 BONE HOLDING FORCEP 250 MM
- A4200-0821 PELVIC MOULD PLATE
- A4200-0822 RECONSTRUCTION MOULD PLATE
- A4200-0823 REDUCTION FORCEP CURVED 280 MM
- A4200-0824 PELVIC RECONSTRUCTION FORCEP LARGE 330 MM
- A4200-0825 PELVIC REDUCTION FORCEP WITH 2 BALL-TIPPED 400 MM
- A4200-0826 PELVIC REDUCTION FORCEP WITH 2 HIGH-LOW-BALL-TIPPED 400 MM
- A4200-0827 PELVIC REDUCTION FORCEP WITH 3 BALL-TIPPED 400 MM
- A4200-0828 PLATE BENDER
- A4200-0829 BONE HOOK
- A4200-0830 T-HANDLE BONE HOOK
- A4200-0831 ALUMINIUM BOX

PELVIC RECONSTRUCTION PLATE INSTRUMENT SET

ORTHOPAEDIC SURGERY INSTRUMENT SETS

MICRO PLATE INSTRUMENT SET

A4200-0300

- MICRO PLATE INSTRUMENT SET**
 A4200-0301 SCREW BOX 1,5/2,0/2,7 MM
 A4200-0302 DEPTH GAUGE 0-40 MM
 A4200-0303 BONE ELEVATOR LARGE
 A4200-0304 BONE ELEVATOR MEDIUM
 A4200-0305 BONE ELEVATOR SMALL
 A4200-0306 DISSECTOR 5 MM
 A4200-0307 DISSECTOR 3 MM
 A4200-0308 BENDING IRON
 A4200-0309 COUNTERSINK HA 2,7 MM
 A4200-0310 COUNTERSINK HA 2,0 MM
 A4200-0311 TAP HA 2,0 MM
 A4200-0312 TAP HA 2,7 MM
 A4200-0313 SHARP HOOK
 A4200-0314 DRILL BIT Ø1,5 MM
 A4200-0315 DRILL BIT Ø2,0 MM
 A4200-0316 SCREW FORCEPS
 A4200-0317 GUIDE Ø2,0/Ø2,7 MM
 A4200-0318 GUIDE Ø1,5/Ø2,0 MM
 A4200-0319 PLATE-BENDING FORCEPS
 A4200-0320 WIRE CUTTER
 A4200-0321 BONE RIBBING RONGEUR
 A4200-0322 POINTED-TIP REDUCTION FORCEPS
 A4200-0323 BENT-TIP REDUCTION FORCEPS
 A4200-0324 PLATE-HOLD FORCEPS
 A4200-0325 HEXAGONAL SCREWDRIVER SW2,0
 A4200-0326 SKIN RETRACTOR
 A4200-0327 ALUMINIUM BOX

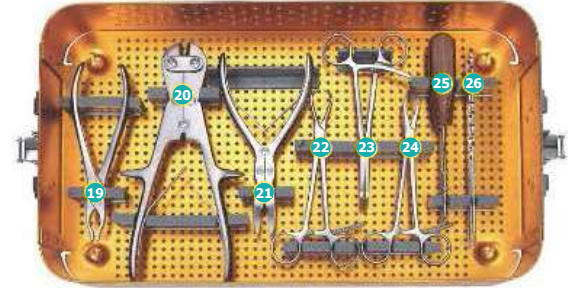
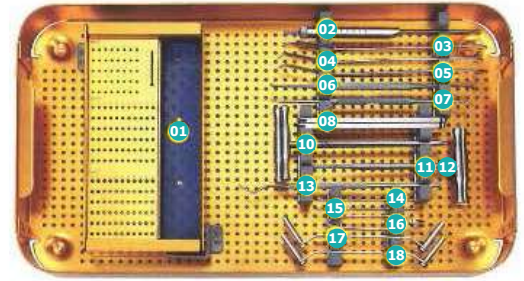

MINI FRAGMENT PLATE INSTRUMENT SET

A4200-0400

- MINI FRAGMENT PLATE INSTRUMENT SET**
 A4200-0401 TAP HA 2,4
 A4200-0402 GUIDE 1,5/2,4
 A4200-0403 DRILL BIT 1,5X100 MM
 A4200-0404 TAP HA 2,0
 A4200-0405 GUIDE 1,2/2,0 MM
 A4200-0406 DRILL BIT 1,2X100 MM
 A4200-0407 TAP HA 2,7 MM
 A4200-0408 GUIDE 2,0/2,7 MM
 A4200-0409 DRILL BIT 2,0X100 MM
 A4200-0410 PLATE-HOLDING FORCEPS
 A4200-0411 PLATE-BENDING FORCEPS
 A4200-0412 RETRACTORS 1X3 MM
 A4200-0413 DISSECTOR 5,0 MM
 A4200-0414 DISSECTOR 3,0 MM
 A4200-0415 SHARP HOOK
 A4200-0416 BENDING IRON
 A4200-0417 WIRE CUTTER
 A4200-0418 T-HANDLE QUICK COUPLING
 A4200-0419 SCREW FORCEPS
 A4200-0420 POINTED-TIP REDUCTION FORCEPS
 A4200-0421 BENT-TIP REDUCTION FORCEPS
 A4200-0422 SHAPE-MADE FORCEPS
 A4200-0423 QUICK COUPLING SCREWDRIVER HEXAGONAL (SW2,0)
 A4200-0424 COUNTERSINK
 A4200-0425 DEPTH GAUGE 0-50 MM
 A4200-0426 SKIN RETRACTOR
 A4200-0427 ALUMINIUM BOX
 A4200-0428 DEPTH GAUGE 0-30 MM
 A4200-0429 STRAIGHT-HANDLE QUICK COUPLING
 A4200-0430 HEXAGONAL SCREWDRIVER SW 2,0 MM
 A4200-0431 ALUMINIUM BOX

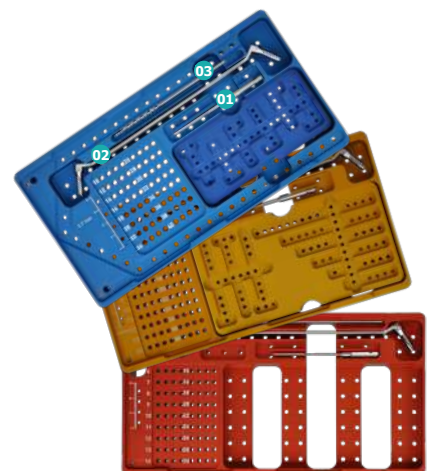

ORTHOPAEDIC SURGERY INSTRUMENT SETS

1,5/2,0 MM MAXILLOFACIAL PLATE INSTRUMENT SET



A3128-0100

- A3128-0101 HOLLOW REAMER 1,5 MM
- A3128-0102 HOLLOW REAMER 2,0 MM
- A3128-0103 SCREWDRIVER FOR 1,5 MM SCREW
- A3128-0104 SCREWDRIVER FOR 2,0 MM SCREW
- A3128-0105 SCREWDRIVER FOR 2,0 MM SCREW
- A3128-0106 LIMITED DRILL BIT 1,6X5 MM
- A3128-0107 LIMITED DRILL BIT 1,6X6 MM
- A3128-0108 LIMITED DRILL BIT 1,6X7 MM
- A3128-0109 LIMITED DRILL BIT 1,6X9 MM
- A3128-0110 LIMITED DRILL BIT 1,6X11 MM
- A3128-0111 LIMITED DRILL BIT 1,6X13 MM
- A3128-0112 LIMITED DRILL BIT 1,6X15 MM
- A3128-0113 LIMITED DRILL BIT 1,1X4 MM
- A3128-0114 LIMITED DRILL BIT 1,1X5 MM
- A3128-0115 LIMITED DRILL BIT 1,1X6 MM
- A3128-0116 LIMITED DRILL BIT 1,1X7 MM
- A3128-0117 LIMITED DRILL BIT 1,1X9 MM
- A3128-0118 LIMITED DRILL BIT 1,1X11 MM
- A3128-0119 QUICK COUPLING HANDLE
- A3128-0120 GUIDE 1,1 MM & 1,6 MM
- A3128-0121 ALUMINIUM BOX

1,5/2,0 MM MAXILLOFACIAL PLATE INSTRUMENT SET

2,4 MM MAXILLOFACIAL PLATE INSTRUMENT SET

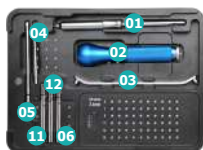

A3128-0200

- A3128-0201 DEPTH GAUGE 0-30 MM
- A3128-0202 QUICK COUPLING HANDLE
- A3128-0203 GUIDE 1,9 MM
- A3128-0204 COUNTERSINK DRILL 2,0 MM
- A3128-0205 SCREWDRIVER FOR 2,4 MM SCREW
- A3128-0206 LIMITED DRILL BIT 1,9X5 MM
- A3128-0207 LIMITED DRILL BIT 1,9X7 MM
- A3128-0208 LIMITED DRILL BIT 1,9X9 MM
- A3128-0209 LIMITED DRILL BIT 1,9X11 MM
- A3128-0210 LIMITED DRILL BIT 1,9X13 MM
- A3128-0211 LIMITED DRILL BIT 1,9X15 MM
- A3128-0212 PLATE SHAPING FORCEPS ROUND
- A3128-0213 PLATE BENDER
- A3128-0214 PLATE SHAPING FORCEPS
- A3128-0215 ALUMINIUM BOX

2,4 MM MAXILLOFACIAL PLATE INSTRUMENT SET



ORTHOPAEDIC SURGERY INSTRUMENT SETS

STERNUM RIB PLATE INSTRUMENT SET

A4200-0900

STERNUM RIB PLATE INSTRUMENT SET

- A4200-0901 REDUCTION FORCEPS DOUBLE LARGE
- A4200-0902 REDUCTION FORCEPS CURVED
- A4200-0903 REDUCTION FORCEPS DOUBLE SMALL
- A4200-0904 REDUCTION FORCEPS SINGLE
- A4200-0905 PLATE INSERT FORCEPS
- A4200-0906 RIB PLATE CUTTER
- A4200-0907 PERIOSTEAL ELEVATOR 9 MM
- A4200-0908 PERIOSTEAL ELEVATOR 12 MM
- A4200-0909 ALUMINIUM BOX

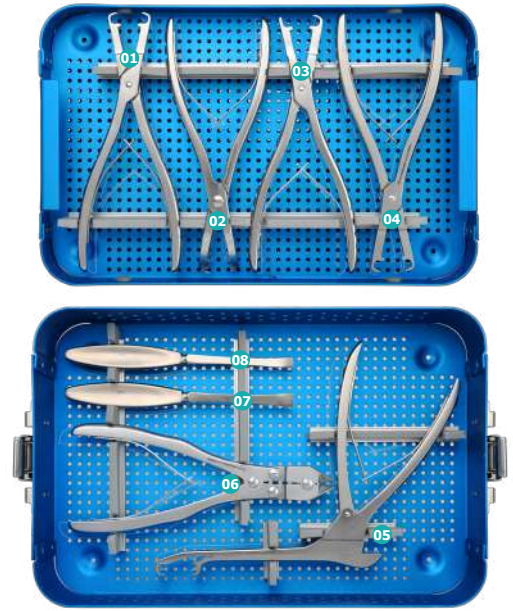

3,5/4,5 MM ANGLED BLADE PLATE INSTRUMENT SET

A4200-1600

3,5/4,5 MM ANGLED BLADE PLATE INSTRUMENT SET

- A4200-1601 INSERTER - EXTRACTOR FOR ADOLESCENT AND CHILDREN
- A4200-1602 INSERTER-EXTRACTOR FOR ADULTS
- A4200-1603 IMPACTOR FOR ANGULAR PLATES
- A4200-1604 SLOTTED HAMMER
- A4200-1605 CHISEL GUIDE
- A4200-1606 TRIANGULAR POSITIONING PLATE 80/70/30 MM
- A4200-1607 TRIANGULAR POSITIONING PLATE 90/50/40 MM
- A4200-1608 TRIANGULAR POSITIONING PLATE 100/60/20 MM
- A4200-1609 QUADRANGULAR POSITIONING PLATE 110/90/90/70 MM



ORTHOPAEDIC SURGERY INSTRUMENT SETS

2,7-3,5-4,0 MM CANNULATED SCREW INSTRUMENT SET

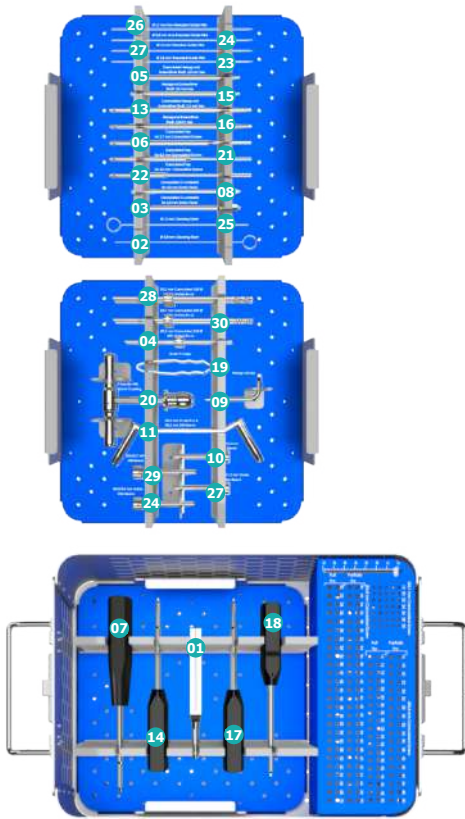

A4200-0600

- 2,7-3,5-4,0 MM CANNULATED SCREW INSTRUMENT SET**
 A4200-0601 MEASURING DEVICE 0-70 MM
 A4200-0602 CLEANING STYLET Ø0,8X130 MM
 A4200-0603 CANNULATED COUNTERSINK Ø6,0 MM
 A4200-0604 CANNULATED DRILL BIT Ø2,2X100 MM
 A4200-0605 CANNULATED HEXAGONAL SCREWDRIVER SHAFT 2,0 MM, QUICK COUPLING
 A4200-0606 CANNULATED TAP FOR 2,7 MM C.SCREW
 A4200-0607 CANNULATED SCREWDRIVER HEXAGONAL 2,5MM
 A4200-0608 CANNULATED COUNTERSINK Ø4,0 MM
 A4200-0609 HEXAGONAL KEY SW 2,5
 A4200-0610 Ø5,0/2,2 MM DRILL SLEEVE
 A4200-0611 DRILL SLEEVE Ø3,2 & PROTECTION SLEEVE Ø5,0 MM
 A4200-0612 ALUMINIUM BOX
 A4200-0613 CANNULATED HEXAGONAL SCREWDRIVER SHAFT, 2,5MM, QUICK COUPLING
 A4200-0614 CANNULATED SCREWDRIVER HEXAGONAL 2,0 MM
 A4200-0615 HEXAGONAL SCREWDRIVER SHAFT, 2,0MM, QUICK COUPLING
 A4200-0616 HEXAGONAL SCREWDRIVER SHAFT, 2,5MM, QUICK COUPLING
 A4200-0617 SCREWDRIVER HEXAGONAL 2,0 MM
 A4200-0618 SCREWDRIVER HEXAGONAL 2,5 MM
 A4200-0619 SCREW FORCEPE
 A4200-0620 T-HANDLE QUICK COUPLING
 A4200-0621 CANNULATED TAP FOR 3,5 MM C.SCREW
 A4200-0622 CANNULATED TAP FOR 4,0 MM C.SCREW
 A4200-0623 GUIDE WIRE Ø0,8X130 MM
 A4200-0624 Ø5,0/0,8 MM GUIDE WIRE SLEEVE
 A4200-0625 CLEANING STYLET Ø1,0X130 MM
 A4200-0626 GUIDE WIRE Ø1,0X130 MM
 A4200-0627 Ø5,0/1,0 MM GUIDE WIRE SLEEVE
 A4200-0628 CANNULATED DRILL BIT Ø3,2X130 MM
 A4200-0629 Ø5,0/2,7 MM DRILL SLEEVE
 A4200-0630 CANNULATED DRILL BIT Ø2,7X130 MM

4,5-6,5-7,3 MM CANNULATED SCREW INSTRUMENT SET

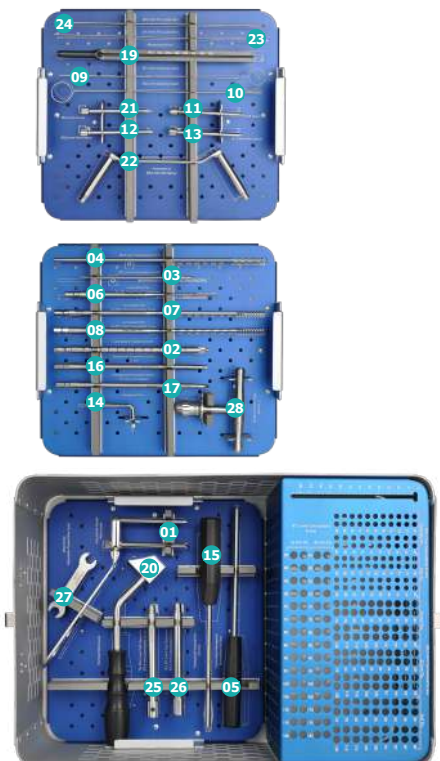

A4200-7300

- 4,5-6,5-7,3 MM CANNULATED SCREW INSTRUMENT SET**
 A4200-7301 ADJUSTABLE PARALLEL WIRE GUIDE
 A4200-7302 CANNULATED COUNTERSINK Ø8,0 MM
 A4200-7303 CANNULATED DRILL BIT Ø3,2X180 MM
 A4200-7304 CANNULATED DRILL BIT Ø4,5X250 MM
 A4200-7305 CANNULATED HEXAGONAL SCREWDRIVER 3,5 HEX
 A4200-7306 CANNULATED TAP FOR Ø4,5 MM CANNULATED SCREW
 A4200-7307 CANNULATED TAP FOR Ø6,5 MM CANNULATED SCREW
 A4200-7308 CANNULATED TAP FOR Ø7,3 MM CANNULATED SCREW
 A4200-7309 CLEANING STYLET Ø1,4X250 MM
 A4200-7310 CLEANING STYLET Ø2,0X250 MM
 A4200-7311 DRILL SLEEVE Ø3,2 MM
 A4200-7312 GUIDE WIRE SLEEVE Ø2,0 MM
 A4200-7313 GUIDE WIRE SLEEVE Ø1,4 MM
 A4200-7314 HEXAGONAL KEY 3,0 MM HEX
 A4200-7315 HEXAGONAL SCREWDRIVER 3,5 MM HEX
 A4200-7316 HEXAGONAL SCREWDRIVER SHAFT, 3,5 MM, QUICK COUPLING
 A4200-7317 HEXAGONAL SCREWDRIVER SHAFT, 3,5 MM, QUICK COUPLING CANN.
 A4200-7318 HOLDING SCREW
 A4200-7319 MEASURING DEVICE
 A4200-7320 MULTIPLE WIRE GUIDE
 A4200-7321 Ø2,5 MM TROCAR
 A4200-7322 PROTECTION SLEEVE Ø5,3 MM & DRILL SLEEVE Ø4,5 MM
 A4200-7323 THREADED GUIDE WIRE Ø1,4X250 MM
 A4200-7324 THREADED GUIDE WIRE Ø2,0X250 MM
 A4200-7325 THREADED DRILL SLEEVE Ø4,5 MM
 A4200-7326 THREADED TAP SLEEVE Ø7,3 MM
 A4200-7327 WRENCH FOR ADJUSTABLE PARALLEL WIRE GUIDE
 A4200-7328 T-HANDLE WITH QUICK COUPLING
 A4200-7329 ALUMINIUM BOX
 A4200-7330 LID
 A4200-7331 TRAYS
 A4200-7332 SCREW TRAY

ORTHOPAEDIC SURGERY INSTRUMENT SETS

PIN-WIRE INSTRUMENT SET

A6200-0100

- A6200-0101 VISE GRIP
- A6200-0102 T-HANDLE WITH JACOB'S CHUCK SMALL
- A6200-0103 WIRE BENDING
- A6200-0104 WIRE CUTTER -1
- A6200-0105 WIRE CUTTER -2
- A6200-0106 WIRE PASSER

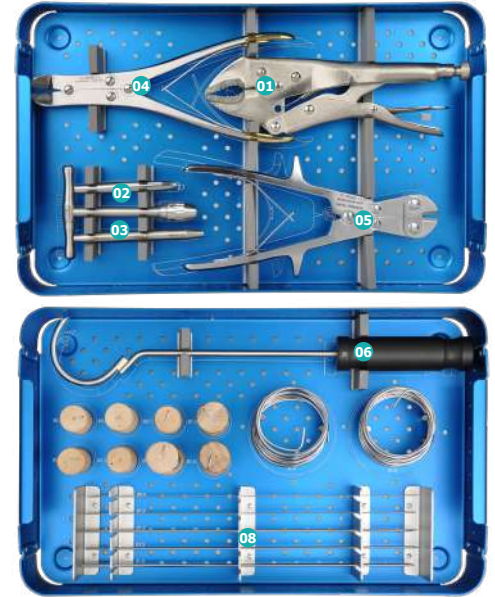

SCREW REMOVAL INSTRUMENT SET

A4200-1000

- A4200-1001 HOLLOW REAMER Ø4,0 MM
- A4200-1002 HOLLOW REAMER Ø5,0 MM
- A4200-1003 HOLLOW REAMER Ø6,5 MM
- A4200-1004 HOLLOW REAMER Ø8,0 MM
- A4200-1005 HOLLOW REAMER Ø10 MM
- A4200-1006 SPINAL MONOAXIAL PEDICLE SCREWDRIVER
- A4200-1007 TORX SCREWDRIVER Ø5,3 MM
- A4200-1008 TORX SCREWDRIVER Ø4,3 MM
- A4200-1009 TORX SCREWDRIVER Ø3,8 MM
- A4200-1010 TORX SCREWDRIVER Ø3,4 MM
- A4200-1011 TORX SCREWDRIVER Ø3,2 MM
- A4200-1012 TORX SCREWDRIVER Ø2,7 MM
- A4200-1013 TORX SCREWDRIVER Ø2,3 MM
- A4200-1014 HEXAGONAL SCREWDRIVER SW 5,5 MM
- A4200-1015 HEXAGONAL SCREWDRIVER SW 5,0 MM
- A4200-1016 HEXAGONAL SCREWDRIVER SW 4,5 MM
- A4200-1017 HEXAGONAL SCREWDRIVER SW 4,0 MM
- A4200-1018 HEXAGONAL SCREWDRIVER SW 3,5 MM
- A4200-1019 HEXAGONAL SCREWDRIVER SW 3,0 MM
- A4200-1020 HEXAGONAL SCREWDRIVER SW 2,5 MM
- A4200-1021 HEXAGONAL SCREWDRIVER SW 2,0 MM
- A4200-1022 HEXAGONAL SCREWDRIVER SW 1,5 MM
- A4200-1023 SQUARE SCREWDRIVER SW 1,5 MM
- A4200-1024 SQUARE SCREWDRIVER SW 1,2 MM
- A4200-1025 SQUARE SCREWDRIVER SW 1,1 MM
- A4200-1026 PHILLIPS SCREWDRIVER
- A4200-1027 SLOTTED SCREWDRIVER LARGE
- A4200-1028 SLOTTED SCREWDRIVER SMALL
- A4200-1029 EXTRACTION SCREW HEXAGONAL 2,5X0,5 MM CONICAL
- A4200-1030 EXTRACTION SCREW HEXAGONAL 2,5 MM CONICAL
- A4200-1031 EXTRACTION SCREW HEXAGONAL 3,5 MM CONICAL
- A4200-1032 EXTRACTION SCREW HEXAGONAL 4,0 MM CONICAL
- A4200-1033 EXTRACTION BOLT Ø3,5 MM
- A4200-1034 EXTRACTION BOLT Ø4,5 MM
- A4200-1035 EXTRACTION BOLT Ø6,0 MM
- A4200-1036 EXTRACTION BOLT Ø6,5 MM
- A4200-1037 HOLLOW REAMER Ø3,0 MM
- A4200-1038 HOLLOW REAMER Ø2,7 MM
- A4200-1039 ROUND GAUGE 8 MM
- A4200-1040 TIP SCREWDRIVER
- A4200-1041 SHARP HOOK
- A4200-1042 HIGH SPEED DRILL BIT Ø4,0X80 MM
- A4200-1043 HIGH SPEED DRILL BIT Ø6,0X80 MM
- A4200-1044 HIGH SPEED DRILL BIT Ø8,0X80 MM
- A4200-1045 SCREW EXTRACTOR
- A4200-1046 I-HANDLE WITH QUICK COUPLING
- A4200-1047 T-HANDLE WITH QUICK COUPLING
- A4200-1048 PLIERS FOR SCREW REMOVAL
- A4200-1049 ALUMINIUM BOX

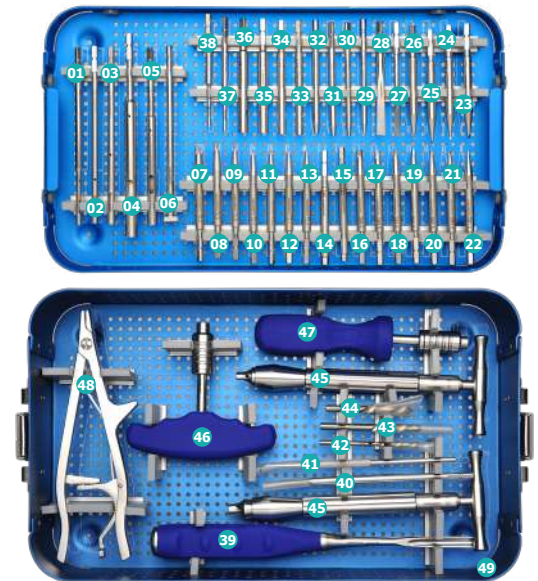

ORTHOPAEDIC SURGERY INSTRUMENT SETS

HERBERT CANNULATED SCREW INSTRUMENT SET

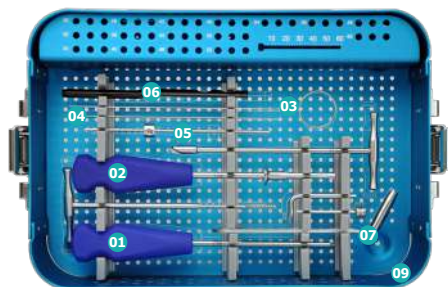

A4200-1500

- A4200-1501
- A4200-1502
- A4200-1503
- A4200-1504
- A4200-1505
- A4200-1506
- A4200-1507
- A4200-1508
- A4200-1509

HERBERT CANNULATED SCREW INSTRUMENT SET

- Ø2,0 MM SCREWDRIVER HEXAGONAL
- Ø2,0 MM CANNULATED SCREWDRIVER HEXAGONAL
- CLEANING STYLET
- KIRSCHNER WIRE
- Ø2,2X150 MM CANNULATED DRILL BIT
- MEASURING DEVICE
- PARALLEL SLEEVE
- SCREW FORCEPS
- ALUMINIUM BOX



HUMERAL INTRAMEDULLARY NAIL INSTRUMENT SET

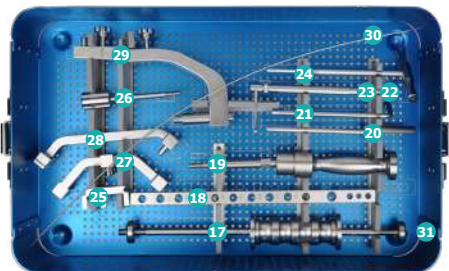
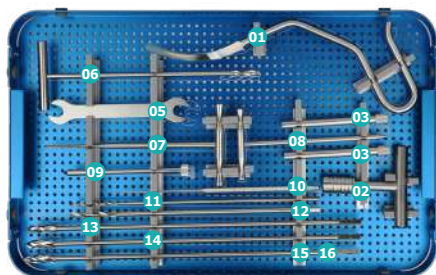

A1200-0100

- A1200-0101
- A1200-0102
- A1200-0103
- A1200-0104
- A1200-0105
- A1200-0106
- A1200-0107
- A1200-0108
- A1200-0109
- A1200-0110
- A1200-0111
- A1200-0112
- A1200-0113
- A1200-0114
- A1200-0115
- A1200-0116
- A1200-0117
- A1200-0118
- A1200-0119
- A1200-0120
- A1200-0121
- A1200-0122
- A1200-0123
- A1200-0124
- A1200-0125
- A1200-0126
- A1200-0127
- A1200-0128
- A1200-0129
- A1200-0130
- A1200-0131

HUMERAL INTRAMEDULLARY NAIL INSTRUMENT SET

- AWL
- QUICK COUPLING T-HANDLE
- SLEEVE Ø8-Ø6 MM
- HUMERUS APPARATUS 160 MM
- OPEN WRENCH
- DRILL BIT Ø5,2 MM WITH T-HANDLE
- TAP Ø3,5 MM
- SCREWDRIVER SW 2,5 MM
- DISTAL POSITIONING FRAME
- DEPTH GAUGE 0-60 MM
- DRILL BIT Ø2,9X250 MM
- DRILL BIT Ø5,2X250 MM
- REAMER Ø9,0X340 MM
- REAMER Ø8,5X340 MM
- REAMER Ø8X340 MM
- REAMER Ø7,0X340 MM
- HAMMER
- GUIDE ROD
- UNIVERSAL JOINT
- GAUGE CANNULA
- HEXAGONAL WRENCH SW 5,0 MM
- DRILL SLEEVE Ø8-Ø5,2 MM
- SLEEVE Ø10-Ø8,0 MM
- LOCATION ROD
- FIXED CONNECTOR
- NAIL CONNECTOR
- PROXIMAL GUIDE
- DISTAL GUIDE
- SIGHTING DEVICE HANDLE
- GUIDE WIRE Ø2,0 MM
- ALUMINIUM BOX

FEMUR ANTEGRADE INTRAMEDULLARY NAIL INSTRUMENT SET

A1200-0300

FEMUR ANTEGRADE INTRAMEDULLARY NAIL INSTRUMENT SET

A1200-0301	UNIVERSAL JOINT
A1200-0302	OPEN WRENCH
A1200-0303	QUICK COUPLING T-HANDLE
A1200-0304	SCREWDRIVER SW 3,5 MM
A1200-0305	TROCAR Ø8 MM
A1200-0306	DEPTH GAUGE 10-100 MM
A1200-0307	T-HANDLE DRILL BIT Ø5,2 MM
A1200-0308	DRILL BIT Ø5,2X300 MM
A1200-0309	DRILL BIT WITH LIMITATOR Ø4,0X300
A1200-0310	DRILL BIT Ø4,0X300 MM
A1200-0311	REAMER Ø10 MM
A1200-0312	REAMER Ø11 MM
A1200-0313	REAMER Ø12 MM
A1200-0314	REAMER Ø13 MM
A1200-0315	DRILL SLEEVE Ø5,2 MM
A1200-0316	HEXAGONAL WRENCH SW 3,0 MM
A1200-0317	HEXAGONAL WRENCH SW 5,0 MM
A1200-0318	DRILL SLEEVE Ø4,0 MM
A1200-0319	FEMUR APPARATUS
A1200-0320	AWL
A1200-0321	HAMMER
A1200-0322	GUIDE ROD
A1200-0323	CONNECTOR ROD
A1200-0324	FIXED CONNECTOR
A1200-0325	SIGHTING DEVICE HANDLE
A1200-0326	BOLT M8X32L
A1200-0327	BOLT M8X41L
A1200-0328	NAIL CONNECTOR
A1200-0329	LOCATION ROD
A1200-0330	LOCATION FORCEP
A1200-0331	CONNECTOR
A1200-0332	DISTAL GUIDE
A1200-0333	GUIDE WIRE
A1200-0334	ALUMINIUM BOX

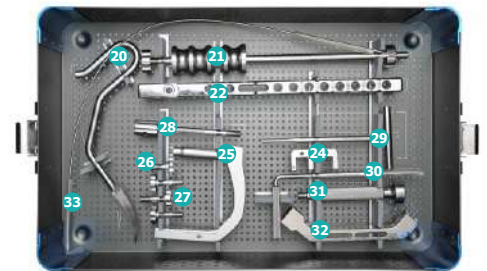
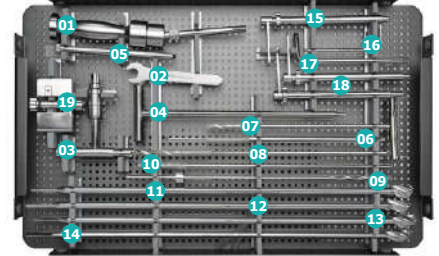

DISTAL FEMUR RETROGRADE & SHORT R PFN INTRAMEDULLARY NAIL INSTRUMENT SET

A1200-0400

DISTAL FEMUR RETROGRADE & SHORT R PFN INTRAMEDULLARY NAIL INSTRUMENT SET

A1200-0401	GUIDE DRILL + SLEEVE
A1200-0402	GUIDE DRILL + SLEEVE
A1200-0403	GUIDE DRILL + SLEEVE
A1200-0404	GUIDE DRILL + SLEEVE
A1200-0405	FORCING CONE
A1200-0406	L- WRENCH LARGE
A1200-0407	L- WRENCH SMALL
A1200-0408	T-HANDLE QUICK COUPLING
A1200-0409	SLEEVE + DRILL BIT
A1200-0410	DRILL BIT WITH LIMITATOR Ø3,5 MM
A1200-0411	WIRE DEPTH GAUGE
A1200-0412	DEPTH GAUGE
A1200-0413	L-SHAPED LOCATION FORCEPS
A1200-0414	TAP
A1200-0415	WRENCH
A1200-0416	LOCATION FORCEPS
A1200-0417	AWL
A1200-0418	GUIDE ROD
A1200-0419	K-WIRE
A1200-0420	STRAIGHT HANDLE
A1200-0421	T-LOCATION FORCEPS
A1200-0422	IMPACTOR AND EXTRACTOR
A1200-0423	UNIVERSAL JOINT
A1200-0424	REAMER Ø10 MM
A1200-0425	REAMER Ø11 MM
A1200-0426	REAMER Ø12 MM
A1200-0427	REAMER Ø13 MM
A1200-0428	GUIDE HANDLE
A1200-0429	WRENCH
A1200-0430	CONNECTOR ROD
A1200-0431	SCREW BOLT
A1200-0432	REAMER Ø9 MM
A1200-0433	GUIDE WIRE
A1200-0434	ALUMINIUM BOX

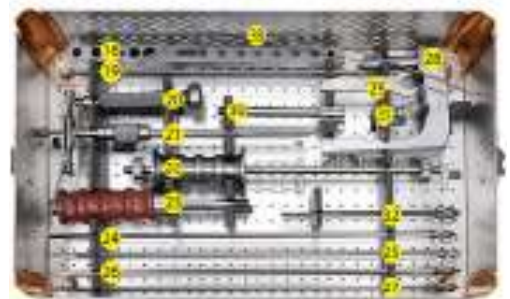
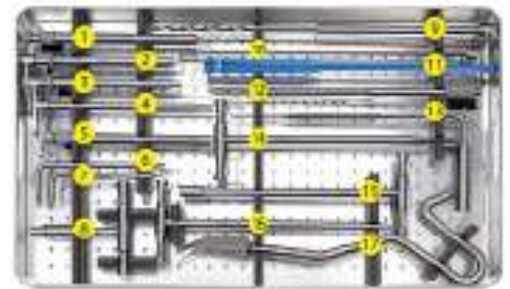

NEW FEMORAL RECONSTRUCTION INTRAMEDULLARY NAIL INSTRUMENT SET

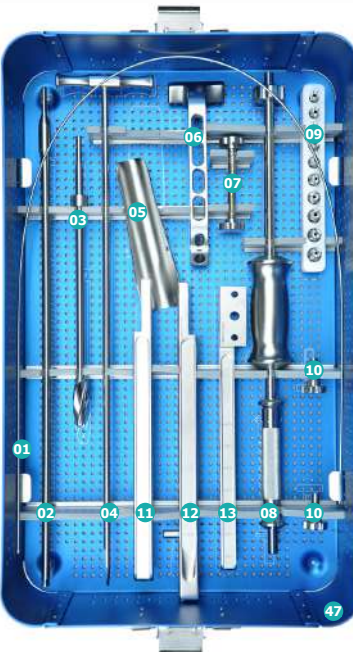
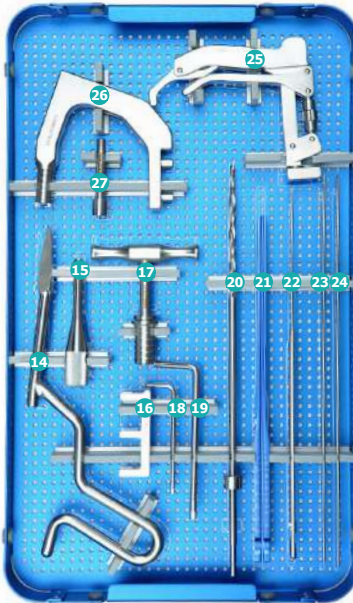

A1200-0800

- A1200-0801
- A1200-0802
- A1200-0803
- A1200-0804
- A1200-0805
- A1200-0806
- A1200-0807
- A1200-0808
- A1200-0809
- A1200-0810
- A1200-0811
- A1200-0812
- A1200-0813
- A1200-0814
- A1200-0815
- A1200-0816
- A1200-0817
- A1200-0818
- A1200-0819
- A1200-0820
- A1200-0821
- A1200-0822
- A1200-0823
- A1200-0824
- A1200-0825
- A1200-0826
- A1200-0827
- A1200-0828
- A1200-0829
- A1200-0830
- A1200-0831
- A1200-0832
- A1200-0833
- A1200-0834
- A1200-0835
- A1200-0836
- A1200-0837
- A1200-0838
- A1200-0839
- A1200-0840
- A1200-0841
- A1200-0842
- A1200-0843
- A1200-0844
- A1200-0845
- A1200-0846
- A1200-0847

NEW FEMORAL RECONSTRUCTION INTRAMEDULLARY NAIL INSTRUMENT SET

- GUIDE WIRE
- FLEXIBLE REAMER
- CANNULATED REAMER Ø13,8 MM STOPPER
- FRACTURE ALIGNMENT DEVICE T-TYPE
- PROTECTION SKIN BOARD
- DISTAL POSITIONING FRAME
- LOCKING WHEELS M8X1,0 MM SW5 SMALL
- CANNULATED PUNCH DEVICE
- FLEXIBLE REAMER BIT Ø8,5-Ø13 MM
- LOCKING WHEELS M8X1 SW5 LARGE
- LONG NAIL DISTAL GUIDE BAR 2
- LONG NAIL DISTAL CONNECTION GUIDE PIN
- LONG NAIL DISTAL GUIDE BAR
- AWL
- NAIL EXTRACTOR
- POSITIONING CARD
- T-HANDLE WITH QUICK COUPLING
- WRENCH SW3
- WRENCH SW5
- DRILL BIT Ø6,4 X 340 MM WITH STOPPER
- MEASURE DEVICE
- DEPTH GUIDE
- THREAD WIRE Ø2,5 X 320 MM
- KIRSCHNER WIRE Ø2,5 X 320 MM
- GUIDE PIN CONTROL DEVICE
- HANDLE
- NAIL LOCKING ROD
- SOFT TISSUE SEPERATION 138 MM
- T-HANDLE DRILL BIT Ø5.2MM FOR DISTAL ALLIGNMENT DEVICE
- SOFT TISSUE SEPERATION 173 MM
- T-HANDLE DISTAL ALIGNMENT DEVICE
- DRILL BIT Ø4,3 X 300 MM
- DRILL BIT Ø4,3 X 300 MM WITH STOPPER
- T-HANDLE HEXAGONAL SCREW DRIVER SW 6,5 MM
- CONNECTING SCREW UNIVERSAL SPANNER SW 6.5 MM
- POSITIONING SLEEVE 120 MM
- T-HANDLE CANNULATED HEXAGONAL SCREW DRIVER SW5
- POSITIONING SLEEVE 155 MM
- HEXAGONAL SCREW SHAFT SW5
- LIMIT DEVICE Ø6,4 MM
- LIMIT DEVICE Ø4,3 MM
- LIMIT DEVICE Ø2,5 MM
- LIMIT DEVICE Ø5,2 MM
- T-HANDLE HEXAGONAL SCREW DRIVER SW 4.0 MM
- DRILL BIT Ø5.2 X 248 MM
- HEXAGONAL SCREW SHAFT SW 4.0 MM
- ALUMINIUM BOX



APFNA FEMUR SHORT NAIL INSTRUMENT SET

A1200-0700

APFNA FEMUR SHORT NAIL INSTRUMENT SET

- A1200-0701 TEMPLATE FOR DEVELOPMENT
- A1200-0702 GUIDE SLEEVE Ø16,5 MM
- A1200-0703 GUIDE PIN SLEEVE Ø16,5/Ø3,2 MM
- A1200-0704 HANDLE WITH QUICK COUPLING
- A1200-0705 PROXIMAL HOLLOW DRILL BIT Ø16,5/Ø3,2 MM
- A1200-0706 HOLLOW OPEN TAPPER
- A1200-0707 PROTECTED PLATEFOR SOFT TISSUE
- A1200-0708 HANDLE
- A1200-0709 CONNECTING BOLT M10X1,5/SW 8,0 MM
- A1200-0710 UNIVERSAL WRENCH OF CONNECTING BOLT SW 8,0 MM
- A1200-0711 MAIN PIN IMPACTOR
- A1200-0712 OPEN WRENCH SW 11 MM
- A1200-0713 IMPACTOR HAMMER
- A1200-0714 PROXIMAL GUIDE BAR
- A1200-0715 GUIDE SLEEVE Ø11,2 MM
- A1200-0716 SUPPORT/COMPRESSION NUT
- A1200-0717 GUIDE SLEEVE FOR PINS Ø11,2/Ø3,2 MM
- A1200-0718 PINS Ø3,2
- A1200-0719 THREAD PIN Ø3,2X400 MM
- A1200-0720 DEPTH GAUGE Ø3,2 MM
- A1200-0721 PROXIMAL HOLLOW POSITION STOPPER Ø10,6/Ø3,2 MM
- A1200-0722 POSITION STOPPER
- A1200-0723 SCREWDRIVER M7X1 L/SW4,5/Ø3,2 MM
- A1200-0724 CONNECTOR
- A1200-0725 WRENCH
- A1200-0726 DISTAL GUIDE BAR 180 MM
- A1200-0727 DISTAL GUIDE BAR 240 MM
- A1200-0728 DISTAL 90 DEGREE GUIDE BAR 180/240 MM
- A1200-0729 DISTAL LOCKING PIN SLEEVE Ø11/Ø8,2 MM
- A1200-0730 SOFT TISSUE SEPERATING DEVICE Ø8,2/Ø4,3 MM
- A1200-0731 SLEEVE PIN Ø4,3 MM
- A1200-0732 DRILL BIT Ø4,3 MM
- A1200-0733 POSITION STOPPER Ø4,3/SW3
- A1200-0734 SMALL WRENCH SW3/Ø4
- A1200-0735 DISTAL LOCKING HOLES DEPTH GAUGE
- A1200-0736 DISTAL LOCKING SCREW WRENCH SW4
- A1200-0737 TAIL HOOK GUIDE PIN Ø2,8 MM
- A1200-0738 TAIL HOLLOW SCREWDRIVER Ø2,8/SW6,5 /SW11
- A1200-0739 TAIL HOLLOW SLEEVE/EXTENSION ROD SW11
- A1200-0740 BLADE NAIL DEVICE M7X1 L/SW 4,5 MM
- A1200-0741 SLIDING HAMMER
- A1200-0742 NAIL REMOVE ROD M10X1,5 MM
- A1200-0743 REDUCTION ROD (GUIDE PIN LEADING DEVICE)
- A1200-0744 BALL HEAD GUIDE PIN Ø2,5/Ø4 MM
- A1200-0745 GUIDE PIN CONTROL DEVICE
- A1200-0746 SOFT EXPANSION TOOL ROD Ø2,5/Ø8 MM
- A1200-0747 SOFT EXPANSION METALLUTGY Ø8-Ø13 MM
- A1200-0748 LONG NAIL DISTAL CONNECTION GUIDE PIN
- A1200-0749 LONG NAIL DISTAL CONNECTION GUIDE BAR LOCK WHEELS M8X1/SW5
- A1200-0750 LOCKING WHEEL SPANNER
- A1200-0751 LONG NAIL DISTAL GUIDE BAR
- A1200-0752 LONG NAIL DISTAL GUIDE PIN LOCKING WHEELS M8X1/SW5
- A1200-0753 LONG NAIL DISTAL POSITIONING FRAME
- A1200-0754 LONG NAIL DISTAL POSITIONING FRAME LOCK WHEELS M6/SW5
- A1200-0755 POSITIONING PIPE Ø10/Ø8,1MM
- A1200-0756 POSITIONING STEM BUSHING NEEDLE Ø8,1 MM
- A1200-0757 POSITIONING STEM DRILLING SHEATH Ø8,1/Ø5,2 MM
- A1200-0758 POSITIONING DRILL ROD Ø5,2 MM
- A1200-0759 POSITIONING STEM FLATS DRILL Ø5,2 MM
- A1200-0760 POSITIONING ROD Ø8,1/Ø5,2 MM
- A1200-0761 POSITIONING CARD
- A1200-0762 ALUMINIUM BOX

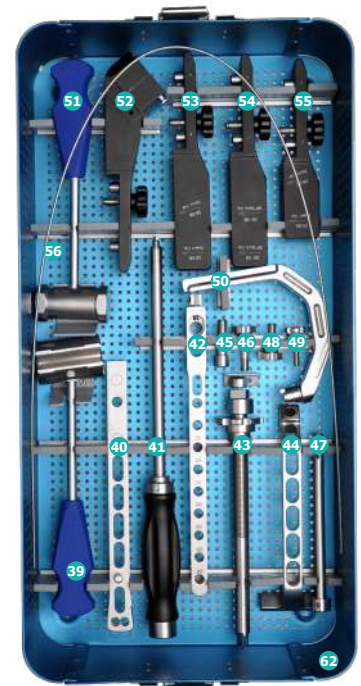
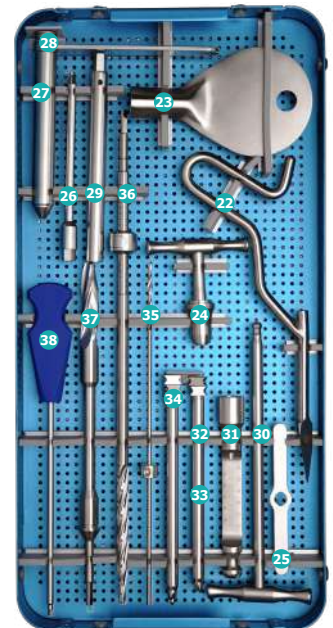
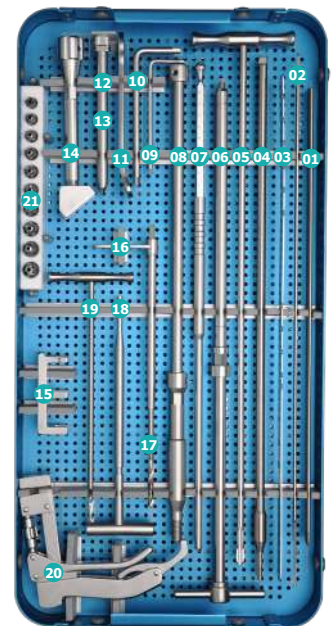

ANT TIBIAL INTRAMEDULLARY NAIL INSTRUMENT SET

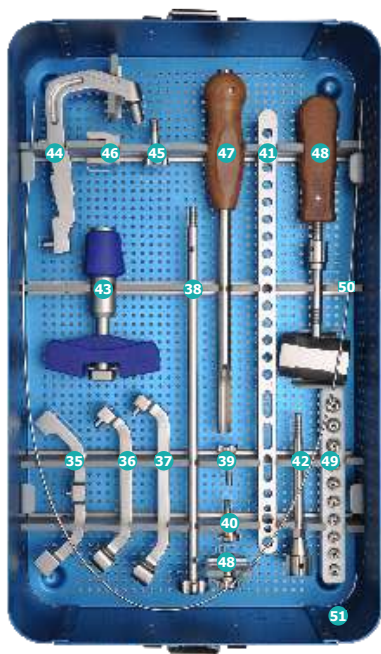
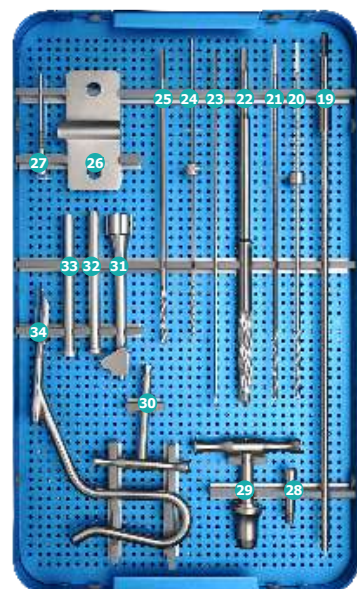

A1200-0900

- A1200-0901 HEXAGONAL SCREW HOLDER SW 3,5 MM
- A1200-0902 T-HANDLE CONNECTING ROD UNIVERSAL DRIVER SW 6.5 MM
- A1200-0903 T-HANDLE HEXAGONAL SCREW DRIVER SW 3.5 MM
- A1200-0904 HEXAGONAL SCREW DRIVER SHAFT SW 3.5 MM
- A1200-0905 RULER FOR PERFECT TIBIAL NAIL
- A1200-0906 FRACTURE ALIGNMENT DEVICE T-TYPE
- A1200-0907 T-HANDLE DRILL BIT Ø5.2MM FOR DISTAL ALIGNMENT DEVICE
- A1200-0908 DISTAL ALIGNMENT DEVICE T-HANDLE
- A1200-0909 DEPTH GAUGE
- A1200-0910 PROTECTION SLEEVE WITH 3.2 DRILL SLEEVE & TROCER PIN
- A1200-0911 SOFT TISSUE SEPERATOR
- A1200-0912 DRILL SLEEVE 8.0 X 5.2 MM
- A1200-0913 DRILL SLEEVE 8.0 X 4.0 MM
- A1200-0914 DRILL STOPPER KEY SW 3,0 MM
- A1200-0915 FRAME RODS LOCKING KEY SW 5,0 MM
- A1200-0916 SMALL WRENCH
- A1200-0917 COMBINATION WRENCH
- A1200-0918 PROTECTION SLEEVE Ø 12 MM
- A1200-0919 REAMER SHAFT
- A1200-0920 DRILL STOPPER Ø 4.0 MM
- A1200-0921 DRILL BIT Ø 4. 0 MM
- A1200-0922 CANNULATED DRILL BIT Ø12 MM
- A1200-0923 THREADED GUIDE WIRE Ø3X300 MM
- A1200-0924 DRILL STOPPER Ø 3,2 MM
- A1200-0925 DRILL BIT Ø 5,2 MM
- A1200-0926 SKIN PROTECTOR
- A1200-0927 COMPRESSION BOLT
- A1200-0928 CONNECTING SCREW CANNULATED
- A1200-0929 T-HANDLE QUICK COUPLING
- A1200-0930 T-HANDLE CONNECTING ROD SCREWDRIVER SW 6.5 MM
- A1200-0931 CONNECTOR FOR INSERTION HANDLE
- A1200-0932 PROTECTION SLEEVE 8.1 ID X 10 OD - 1
- A1200-0933 PROTECTION SLEEVE 8.1 ID X 10 OD - 2
- A1200-0934 CANNULATED AWL
- A1200-0935 PROXIMAL AIMING ARM-ANGULAR
- A1200-0936 PROXIMAL AIMING ARM
- A1200-0937 DISTAL AIMING ARM
- A1200-0938 SLIDING HAMMER GUIDE ROD
- A1200-0939 CONNECTING PART OF DISTAL AIMING ARM
- A1200-0940 CONNECTING BOLT Ø 6.0 MM
- A1200-0941 DISTAL JIG GUIDE
- A1200-0942 NAIL EXTRACTOR
- A1200-0943 GUIDE WIRE HOLDER
- A1200-0944 INSERTION HANDLE
- A1200-0945 CONNECTING BOLT Ø 8.0 MM
- A1200-0946 POSITIONING BLOCK FOR DISTAL ALLIGNMENT DEVICE
- A1200-0947 CANNULATED CUTTER FOR PERFECT TIBIAL NAIL Ø 12 MM
- A1200-0948 SLIDING HAMMER
- A1200-0949 REAMER HEAD
- A1200-0950 GUIDE WIRE
- A1200-0951 ALUMINIUM BOX

ORTHOPAEDIC SURGERY INSTRUMENT SETS

TIBIAL INTRAMEDULLARY NAIL INSTRUMENT SET

A1200-0200

TIBIAL INTRAMEDULLARY NAIL INSTRUMENT SET

- A1200-0201 UNIVERSAL JOINT
- A1200-0202 SOFT TISSUE SEPERATOR
- A1200-0203 QUICK COUPLING T-HANDLE
- A1200-0204 FIXED CONNECTOR
- A1200-0205 LOCATION ROD
- A1200-0206 SCREWDRIVER
- A1200-0207 T-HANDLE DRILL BIT 5,2 MM
- A1200-0208 DEPTH GAUGE 10-100 MM
- A1200-0209 DRILL BIT 5,2X300 MM
- A1200-0210 DRILL BIT 4,0X300 MM
- A1200-0211 DRILL BIT WITH LIMITATOR 4,0X300 MM
- A1200-0212 GUIDE ROD
- A1200-0213 REAMER 13 MM
- A1200-0214 REAMER 12 MM
- A1200-0215 REAMER 11 MM
- A1200-0216 REAMER 10 MM
- A1200-0217 REAMER 9 MM
- A1200-0218 REAMER 8 MM
- A1200-0219 DISTAL GUIDE
- A1200-0220 SIGHTING DEVICE HANDLE
- A1200-0221 PROXIMAL GUIDE
- A1200-0222 AWL
- A1200-0223 LOCATION FORCEPS
- A1200-0224 DRILL SLEEVE 4,2-10 MM
- A1200-0225 HEXAGONAL WRENCH HEX 5,0 MM
- A1200-0226 HEXAGONAL WRENCH HEX 3,0 MM
- A1200-0227 DRILL SLEEVE 5,4-10 MM
- A1200-0228 BOLT M12X1,0 MM
- A1200-0229 BOLT M8X1,0 MM LONG
- A1200-0230 BOLT M8X1,0 MM
- A1200-0231 NAIL CONNECTOR SOLID
- A1200-0232 NAIL CONNECTOR CANNULATED
- A1200-0233 OPEN WRENCH
- A1200-0234 HAMMER
- A1200-0235 GUIDE WIRE
- A1200-0236 ALUMINIUM BOX

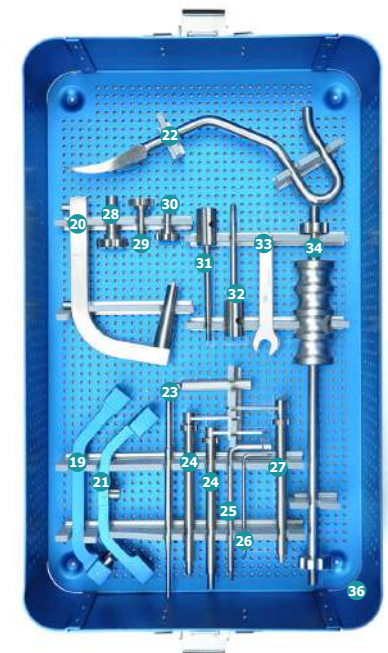
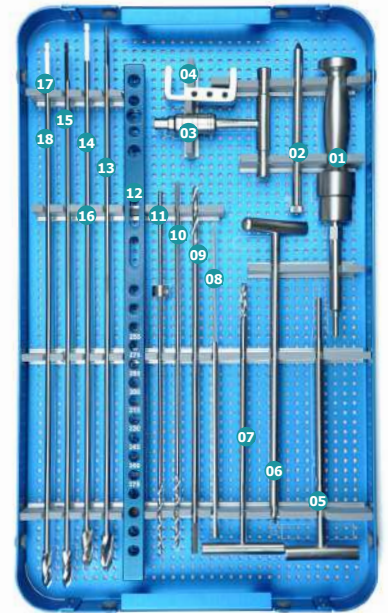

ORTHOPAEDIC SURGERY INSTRUMENT SETS

INTRAMEDULLARY NAIL REMOVAL INSTRUMENT SET

A1200-1200

- A1200-1201
- A1200-1202
- A1200-1203
- A1200-1204
- A1200-1205
- A1200-1206
- A1200-1207
- A1200-1208
- A1200-1209
- A1200-1210
- A1200-1211
- A1200-1212
- A1200-1213
- A1200-1214
- A1200-1215
- A1200-1216
- A1200-1217
- A1200-1218
- A1200-1219
- A1200-1220
- A1200-1221
- A1200-1222
- A1200-1223
- A1200-1224
- A1200-1225

INTRAMEDULLARY NAIL REMOVAL INSTRUMENT SET

- END CUP WRENCH 180 MM
- WRENCH
- WIRE CUTTER
- OPEN WRENCH
- HEXAGONAL SCREWDRIVER SW 4,5 MM
- HEXAGONAL SCREWDRIVER SW 5,0 MM
- LOCKING SCREW EXTRACTOR 250 MM
- HEXAGONAL SCREWDRIVER SW 2,5 MM
- HEXAGONAL SCREWDRIVER SW 3,5 MM
- HEXAGONAL SCREWDRIVER SW 4,0 MM
- T-HANDLE WITH QUICK COUPLING
- EXTRACTOR CHUCK UNIVERSAL LARGE
- EXTRACTOR CHUCK M6
- EXTRACTOR CHUCK SW 4,0 MM
- EXTRACTOR CHUCK SW 4,5 MM
- EXTRACTOR CHUCK M10X1,0 MM
- EXTRACTOR CHUCK M8X1,0 MM
- EXTRACTOR CHUCK M8
- EXTRACTOR CHUCK UNIVERSAL SMALL
- EXTRACTOR CHUCK M11 MM
- EXTRACTOR CHUCK M10 MM
- SAW BLADE SCREWDRIVER
- HAMMER
- UNIVERSAL JOINT
- ALUMINIUM BOX

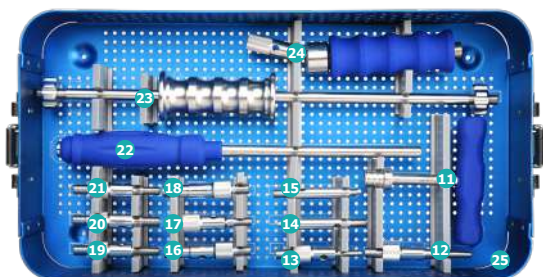
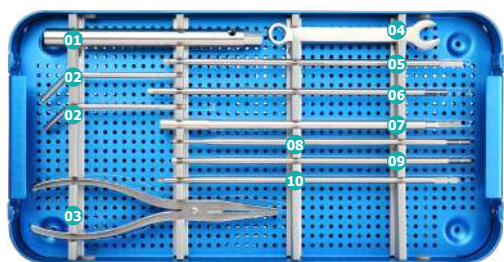

ELASTIC NAIL INSTRUMENT SET

A1200-0600

- A1200-0601
- A1200-0602
- A1200-0603
- A1200-0604
- A1200-0605
- A1200-0606
- A1200-0607
- A1200-0608
- A1200-0609
- A1200-0610
- A1200-0611
- A1200-0612
- A1200-0613
- A1200-0614
- A1200-0615
- A1200-0616
- A1200-0617
- A1200-0618

ELASTIC NAIL INSTRUMENT SET

- HAMMER
- AWL
- EXTRACTION PLIERS
- DOUBLE DRILL SLEEVE Ø3,2-4,5 MM
- END CAP INSERTER LARGE
- END CAP INSERTER SMALL
- NAIL INSERTER
- DRILL BIT 2,7X130 MM
- DRILL BIT 3,2X150 MM
- DRILL BIT 4,5X190 MM
- BENDER 140°
- BENDER 130°
- STANDART TAMP
- BEVELED TAMP
- CUTTER
- HAMMER GUIDE
- KEY OF CUTTER
- ALUMINIUM BOX

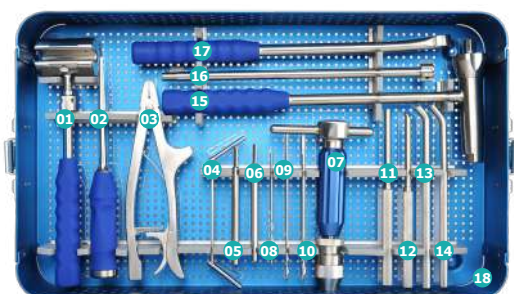
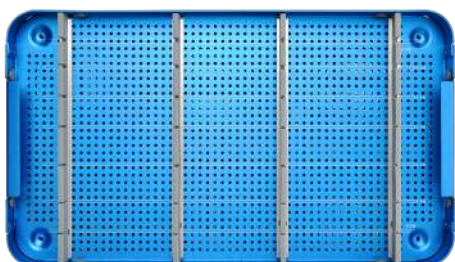

ORTHOPAEDIC SURGERY INSTRUMENT SETS

SPINAL PEDICLE SCREW SYSTEM INSTRUMENT SET

A2200-0100

SPINAL PEDICLE SCREW SYSTEM INSTRUMENT SET

- A2200-0101 FEELER FOR SCREW CHANNEL STRAIGHT
- A2200-0102 HEXAGONAL SCREWDRIVER FOR SREW NUT
- A2200-0103 TAP Ø4,0 MM
- A2200-0104 TAP Ø5,0 MM
- A2200-0105 SCREWDRIVER HEXAGONAL 3,5 MM FOR
- A2200-0106 TAP Ø6,0 MM
- A2200-0107 TAP Ø7,0 MM
- A2200-0108 FEELER FOR SCREW CHANNEL BENT
- A2200-0109 SCREW CUTTER FOR LONG ARM SCREW
- A2200-0110 SCREW NUT HOLDER HEXAGONAL
- A2200-0111 CROSSLINK NUT HOLDER HEXAGONAL
- A2200-0112 IN-SITU BENDING IRON
- A2200-0113 SCREWDRIVER FOR POLYAXIAL SCREW
- A2200-0114 SCREWDRIVER FOR MONOAXIAL SCREW
- A2200-0115 TRAIL ROD
- A2200-0116 INSERT DEVICE FOR FIXATION PIN
- A2200-0117 ROD PUSHERIAL
- A2200-0118 PARALLEL SPREADER
- A2200-0119 PARALLEL COMPRESSOR
- A2200-0120 ROD TWIST
- A2200-0121 PEDICLE PROBE STRAIGHT
- A2200-0122 PEDICLE PROBE BENT
- A2200-0123 AWL
- A2200-0124 T-HANDLE QUICK COUPLING
- A2200-0125 ROD HOLDING FORCEPS
- A2200-0126 ROD BENDER
- A2200-0127 COUNTER TORQUE FOR CUTTER
- A2200-0128 ROD PUSHING FORCEPS
- A2200-0129 STRAIGHT HANDLE QUICK COUPLING
- A2200-0130 COUNTER TORQUE
- A2200-0131 ALUMINIUM BOX

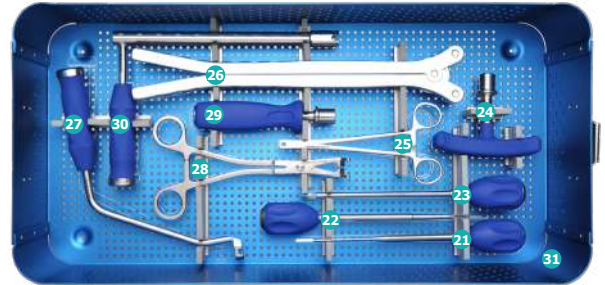
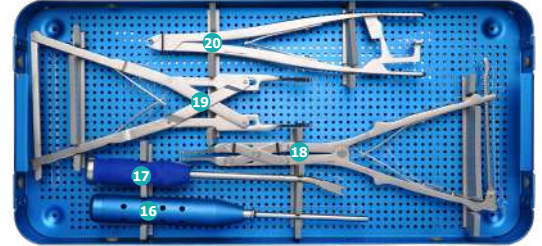
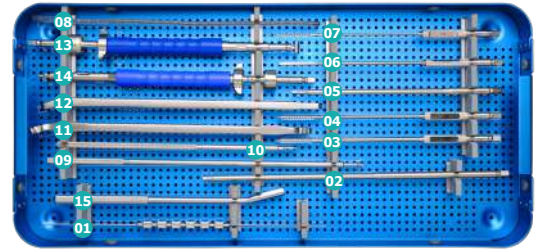

ANTERIOR CERVICAL PLATE SYSTEM INSTRUMENT SET

A2200-0200

ANTERIOR CERVICAL PLATE SYSTEM INSTRUMENT SET

- A2200-0201 SCREWDRIVER SLEEVE
- A2200-0202 SCREWDRIVER SLEEVE
- A2200-0203 DRILL BIT
- A2200-0204 DRILL BIT
- A2200-0205 PLATE AND SCREW BOX
- A2200-0206 CURETTE
- A2200-0207 HEXAGONAL SCREWDRIVER
- A2200-0208 BRACE SCREWDRIVER
- A2200-0209 AWL
- A2200-0210 TAP
- A2200-0211 NUT SCREWDRIVER
- A2200-0212 HEXAGONAL SCREWDRIVER
- A2200-0213 HEXAGONAL SCREWDRIVER
- A2200-0214 PLATE HOLDING FORCEPS
- A2200-0215 CERVICAL HOOK
- A2200-0216 CERVICAL HOOK
- A2200-0217 GUIDE
- A2200-0218 DISTRACTOR
- A2200-0219 BRACE SCREW
- A2200-0220 LOCATION SCREW
- A2200-0221 PLATE BENDER
- A2200-0222 LOCATION SCREW SCREWDRIVER
- A2200-0223 ALUMINIUM BOX

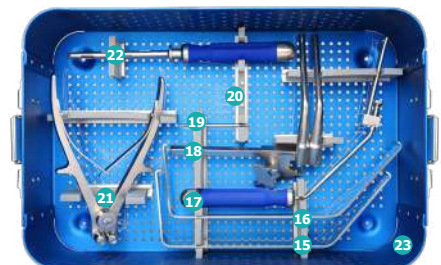
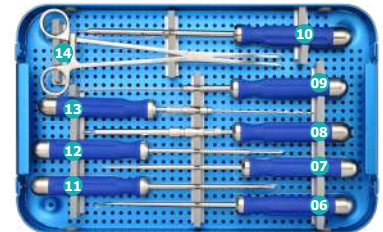
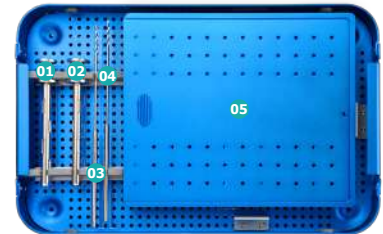

ORTHOPAEDIC SURGERY INSTRUMENT SETS

POSTERIOR CERVICAL FIXATION SYSTEM INSTRUMENT SET

A2200-0300

POSTERIOR CERVICAL FIXATION SYSTEM INSTRUMENT SET

- A2200-0301 DEPTH GAUGE 4-40 MM
- A2200-0302 DRILL BIT 2,7 MM
- A2200-0303 DRILL BIT 2,4 MM
- A2200-0304 TRAIL ROD
- A2200-0305 SCREWDRIVER HEXAGONAL 2,5 MM
- A2200-0306 TAP Ø4,0 MM
- A2200-0307 TAP Ø3,5 MM
- A2200-0308 NUT HOLDER
- A2200-0309 FEELER FOR SCREW CHANNEL BENT
- A2200-0310 FEELER FOR SCREW CHANNEL STRAIGHT
- A2200-0311 DISTRACTOR
- A2200-0312 IN-SITU BENDING IRON L
- A2200-0313 IN-SITU BENDING IRON R
- A2200-0314 T-HANDLE QUICK COUPLING
- A2200-0315 HOOK HOLDING FORCEPS
- A2200-0316 ROD HOLDING FORCEPS
- A2200-0317 GUIDE
- A2200-0318 SCREWDRIVER HEXAGONAL 2,5 MM
- A2200-0319 ROD PUSHING FORCEPS
- A2200-0320 STRAIGHT HANDLE QUICK COUPLING
- A2200-0321 INSERT DEVICE FOR FIXATION PIN
- A2200-0322 COUNTER TORQUE
- A2200-0323 SCREWDRIVER FOR POLYAXIAL SCREW
- A2200-0324 ROD BENDER
- A2200-0325 AWL
- A2200-0326 AWL
- A2200-0327 PROTECTION SLEEVE
- A2200-0328 DISTRACTION FORCEPS
- A2200-0329 ROD CUTTER
- A2200-0330 PARALLEL COMPRESSION FORCEPS
- A2200-0331 ROD TWIST
- A2200-0332 ALUMINIUM BOX

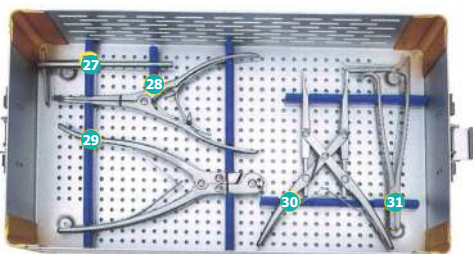
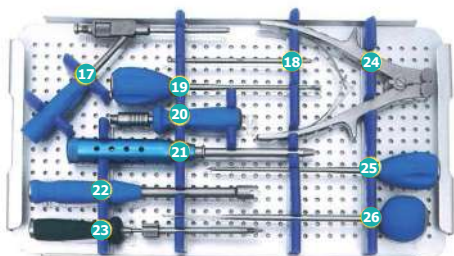
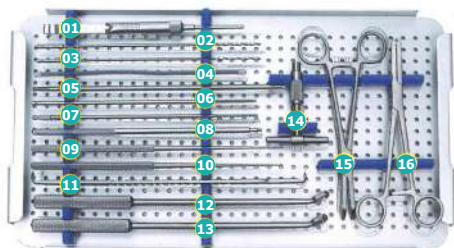

ANTERIOR THORACIC & LUMBAR PLATE SYSTEM INSTRUMENT SET

A2200-0400

ANTERIOR THORACIC & LUMBAR PLATE SYSTEM INSTRUMENT SET

- A2200-0401 CURVED GUIDE PIN
- A2200-0402 STRAIGHT GUIDE PIN
- A2200-0403 DRILL BIT
- A2200-0404 OBTURATOR
- A2200-0405 NUT DRIVER SW 8,0 MM
- A2200-0406 NUT DRIVER SW 8,0 MM
- A2200-0407 DRILL GUIDE
- A2200-0408 DETECTOR
- A2200-0409 HOLE ENLARGER
- A2200-0410 TAP 6,5 MM
- A2200-0411 SCREW HOLDING DRIVER
- A2200-0412 TAP 6 MM
- A2200-0413 SCREWDRIVER
- A2200-0414 UNIVERSAL SCREWDRIVER
- A2200-0415 SCREWDRIVER
- A2200-0416 CALIPERS
- A2200-0417 COMPRESSION CLAMP 3 MM
- A2200-0418 DISTRACTOR CLAMP
- A2200-0419 PLATE HOLDING CLAMP
- A2200-0420 HOLDING BOLT SW 8,0 MM
- A2200-0421 COMBINATION WRENCH
- A2200-0422 WRENCH SW 11 MM
- A2200-0423 ALUMINIUM BOX

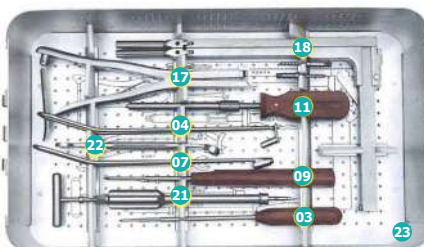
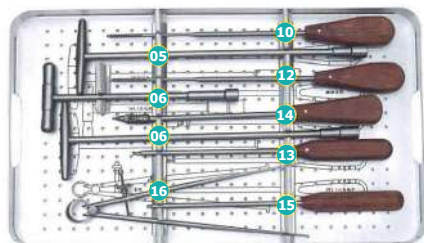
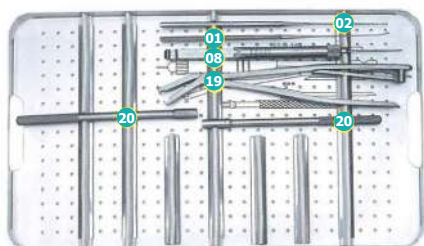

ORTHOPAEDIC SURGERY INSTRUMENT SETS

AYFIX EXTERNAL FIXATOR INSTRUMENT SET

A5200-0100

A5200-0101	TROCAR Ø4.0
A5200-0102	TROCAR Ø5.0
A5200-0103	TROCAR Ø6.0
A5200-0104	HEXAGONAL WRENCH 6.0 MM
A5200-0105	HEXAGONAL WRENCH 5.0 MM
A5200-0106	HEXAGONAL WRENCH 4.0 MM
A5200-0107	DRILL BIT Ø3.5X180 MM
A5200-0108	DRILL BIT Ø2.0X130 MM
A5200-0109	DRILL BIT Ø3.0X130 MM
A5200-0110	T-HANDLE WITH JACOB'S CHUCK (0-6 MM)
A5200-0111	DRILL BIT Ø4.5X210
A5200-0112	PROTECTION SLEEVE Ø11-Ø8 LARGE
A5200-0113	SLEEVE Ø8-Ø6
A5200-0114	SLEEVE Ø8-Ø4.5
A5200-0115	PROTECTION SLEEVE Ø11-Ø8 MEDIUM
A5200-0116	SLEEVE Ø8-Ø5
A5200-0117	SLEEVE Ø8-Ø3.5
A5200-0118	PROTECTION SLEEVE Ø10-Ø7 SMALL
A5200-0119	SLEEVE Ø7-Ø4
A5200-0120	SLEEVE Ø7-Ø3
A5200-0121	SLEEVE Ø7-Ø2
A5200-0122	ALUMINIUM BOX

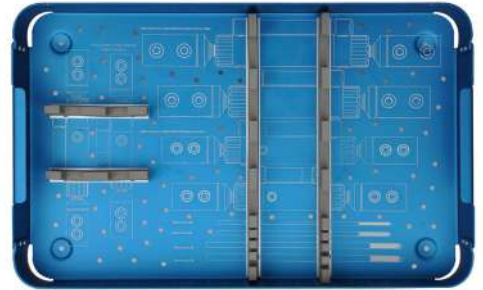
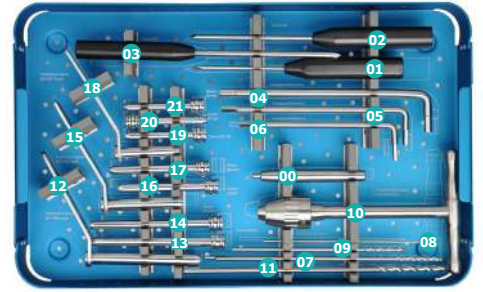

MINI RAIL EXTERNAL FIXATOR INSTRUMENT SET

A5200-0200

A5200-0201	T-WRENCH FOR BONE SCREW
A5200-0202	THREADED WIRE Ø1,6 MM (PACK OF 4) TOTAL LENGTH THREAD
A5200-0203	THREADED WIRE Ø2,0 MM (PACK OF 4) TOTAL LENGTH THREAD
A5200-0204	THREADED WIRE EXTRACTOR
A5200-0205	ALLEN WRENCH 3 MM
A5200-0206	T-WRENCH FOR CLAMP SCREW
A5200-0207	DRILL SLEEVE 2,0/2,5 MM
A5200-0208	BONE DRILL 1,6/2,0 MM
A5200-0209	ALUMINIUM BOX

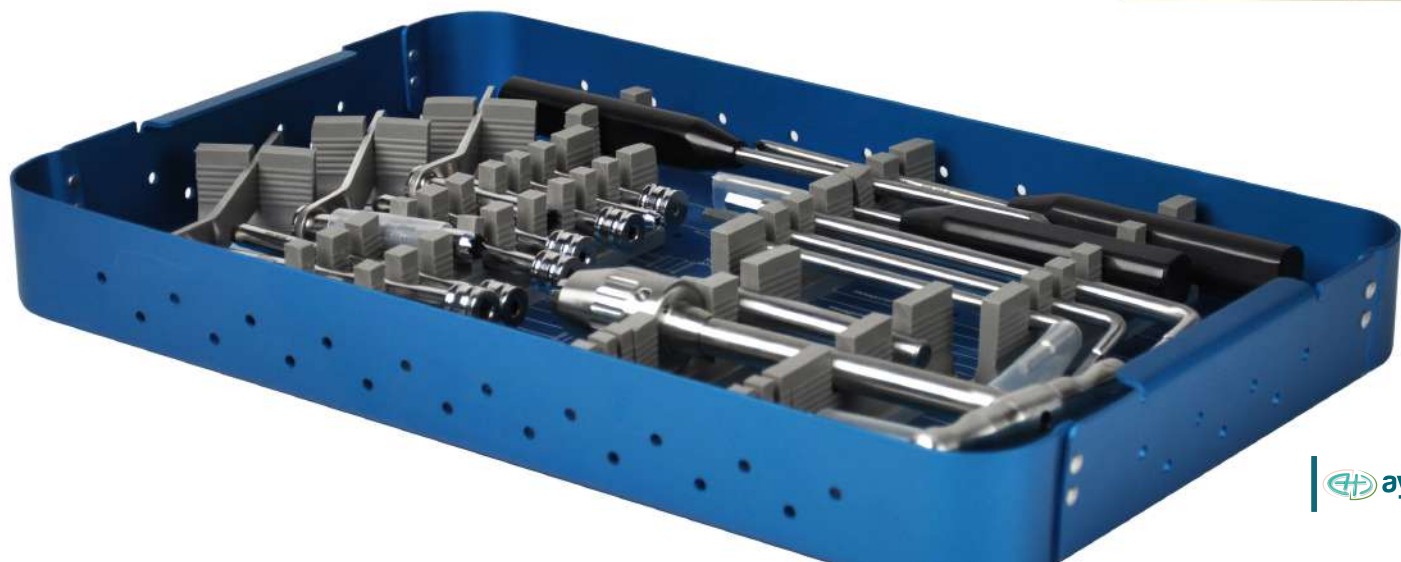
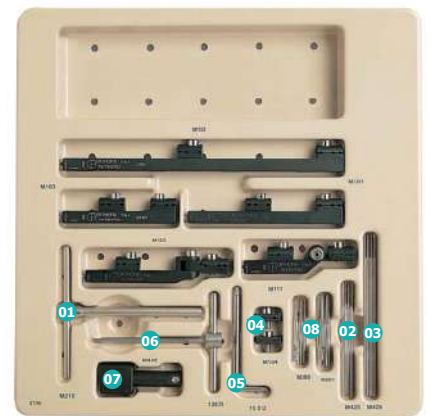

ORTHOPAEDIC SURGERY INSTRUMENT SETS

TUBULAR EXTERNAL FIXATOR INSTRUMENT SET

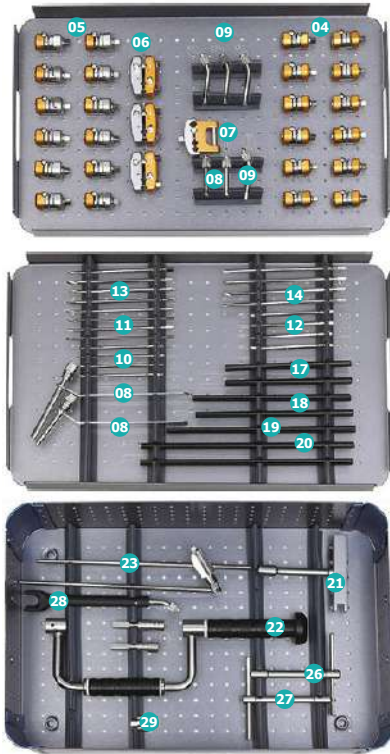

A5200-0300

- A5200-0301
- A5200-0302
- A5200-0303
- A5200-0304
- A5200-0305
- A5200-0306
- A5200-0307
- A5200-0308
- A5200-0309
- A5200-0310
- A5200-0311
- A5200-0312
- A5200-0313
- A5200-0314
- A5200-0315
- A5200-0316
- A5200-0317
- A5200-0318
- A5200-0319
- A5200-0320
- A5200-0321
- A5200-0322
- A5200-0323
- A5200-0324
- A5200-0325
- A5200-0326
- A5200-0327
- A5200-0328
- A5200-0329
- A5200-0330

TUBULAR EXTERNAL FIXATOR INSTRUMENT SET

- HOFFMANN EXTERNAL
- FIXATION SMALL
- FRAGMENT SET
- ROD-ROD COUPLING (5 MM ROD) 12 MM
- ROD-PIN COUPLING (3/4 MM PIN, 5MM ROD) 12 MM
- HOLE PIN CLAMP (3/4 MM PIN) 3,0 MM
- PIN CLAMP (3/4 MM PIN) 1,0 MM
- STRAIGHT POST 2
- DEGREE ANGLED POST
- APEX PIN SELF-DRILLING 3X80 MM
- APEX PIN SELF-DRILLING 3X100 MM
- APEX PIN SELF-DRILLING 4X80 MM
- APEX PIN SELF-DRILLING 4X100 MM
- APEX PIN SELF-DRILLING 4X120 MM
- DRILL SLEEVE 3,0 MM
- DRILL SLEEVE 4,0 MM
- CARBON FIBER CONNECTING ROD 5X120 MM
- CARBON FIBER CONNECTING ROD 5X150 MM
- CARBON FIBER CONNECTING ROD 5X180 MM
- CARBON FIBER CONNECTING ROD 5X200 MM
- T-SHAPED CLAMP WRENCH 5#
- REDUCTION WRENCH
- ELBOW JOINT 5,0 MM
- APEX PIN CHUCK 3,0 MM
- APEX PIN CHUCK 4,0 MM
- T-SHAPED PIN WRENCH 3,0 MM
- T-SHAPED PIN WRENCH 4,0 MM
- ARC DRILLING STAND
- ADJUST WHEEL
- ALUMINUM BOX

HYBRID EXTERNAL FIXATOR INSTRUMENT SET

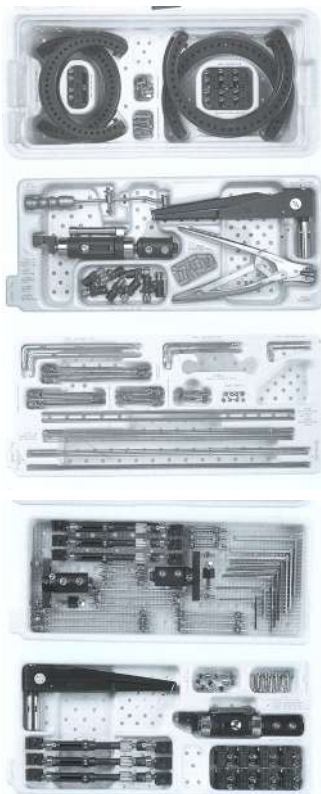

A5200-0400

- A5200-0401
- A5200-0402
- A5200-0403
- A5200-0404
- A5200-0405
- A5200-0406
- A5200-0407
- A5200-0408
- A5200-0409
- A5200-0410
- A5200-0411
- A5200-0412
- A5200-0413
- A5200-0414
- A5200-0415
- A5200-0416
- A5200-0417
- A5200-0418
- A5200-0419
- A5200-0420
- A5200-0421
- A5200-0422
- A5200-0423
- A5200-0424
- A5200-0425
- A5200-0426
- A5200-0427
- A5200-0428
- A5200-0429
- A5200-0430
- A5200-0431
- A5200-0432
- A5200-0433
- A5200-0434
- A5200-0435
- A5200-0436
- A5200-0437
- A5200-0438

HYBRID EXTERNAL FIXATOR INSTRUMENT SET

- 2X30017TWO-HOLE X-WIRE SECURING PIN THREE-HOLE WIRE CLAMP
- SLIDER UNIT
- WIRE GUIDE WIRE TENSIONER
- HYBRID FIXATOR STANDARD ASSEMBLY KIT
- CONSISTING OF: 7 PROCALLUS STANDARD CENTRAL BODY,
- COMPRESSION-DISTRACTION UNIT STANDARD; 7 PROCALLUS STRAIGHT CLAMP;
- HYBRID COUPLING WITH BALL-JOINT. WIRE CUTTER
- SUPPLEMENTARY SCREW HOLDER CLAMP
- X-WIRE COVERS (PACK OF 20)
- ALLEN WRENCH 6 MM ALLEN WRENCH 5 MM
- RADIOLUCENT RINGS (SEE P. 36)
- LOWER TRAY (GENERIC)
- 2X80035 SHEFFIELD CLAMP
- 2X80074 SINGLE SCREW CLAMP
- 3X80047 REDUCTION UNIT
- 3X11137 SCREW GUIDE, LENGTH 80 MM
- 3X 11103 SCREW GUIDE, LENGTH 100 MM
- 1X 11105 DRILL GUIDE 0 4.8 MM, LENGTH 80 MM
- 1X 11138 DRILL GUIDE 0 4.8 MM, LENGTH 60 MM
- 1X80034 BOLTS 60 MM (SET OF 3)
- 1X80036 THREADED BARS, LENGTH 80 MM (SET OF 3)
- 1X80037 THREADED BARS,LENGTH 120 MM (SET OF 3)
- 1X80038 THREADED BARS,LENGTH 160 MM (SET OF 3)
- 1X80039 THREADED BARS,LENGTH 200 MM (SET OF 3) UPPER TRAY
- ALLEN WRENCH 3 MM INDEPENDENT WIRE CLAMP POST, LENGTH 50 MM
- POST, LENGTH 100 MM POST, LENGTH 150 MM
- F.F.S. LARGE WASHERS (PACK OF 4) SUPPLEMENTARY SCREW
- HOLDER BAR 0 6 MM,
- WIRE TENSIONER
- RING LOCKING SCREW
- TWO-HOLE X-WIRE SECURING PIN HYBRID FIXATOR SHORT ASSEMBLY KIT
- CONSISTING OF:- 7 PROCALLUS STRAIGHT CLAMP,
- PROCALLUS SHORT CENTRAL BODY, 7 COMPRESSION
- SUPPLEMENTARY SCREW HOLDER BAR 0 6 MM,
- LENGTH 400 MM X- WIRE WITH LATERAL OLIVE
- 2 MM, LENGTH 400 MM X-WIRE WITH CENTRAL OLIVE 0 2 MM, LENGTH 400 MM
- X-WIRE WITH CENTRAL OLIVE 0 2 MM, LENGTH 450 MM X- WIRE WITHOUT OLIVE
- 2 MM, LENGTH 400 MM X-WIRE WITHOUT OLIVE
- 2 MM, LENGTH 450 MM
- ALUMINUM BOX

ORTHOPAEDIC SURGERY INSTRUMENT SETS

ILIZAROV CIRCULAR EXTERNAL FIXATOR INSTRUMENT SET

A5200-0500	ILIZAROV CIRCULAR EXTERNAL FIXATOR INSTRUMENT SET
A5200-0501	HYBRID EXTERNAL FIXATOR (FOR ADAPTATION TO EXTERNAL CIRCULAR FIXATION SYSTEM)
A5200-0502	T-WRENCH
A5200-0503	WRENCH WITH OPEN-CIRCULAR ENDS
A5200-0504	HEXAGONAL WRENCH
A5200-0505	WRENCH WITH TWO OPEN ENDS
A5200-0506	OSTEOTOME
A5200-0507	WIRE CUTTER
A5200-0508	DOUBLE ENDED OFFSET SOCKET WRENCH
A5200-0509	WIRE TENSIONER
A5200-0510	WIRE TIGHTENER
A5200-0511	SLEEVE GUIDE
A5200-0512	WIRE TENSIONER
A5200-0513	DRILL GUIDE
A5200-0514	DRILL GUIDE WITHOUT HANDLE
A5200-0515	ADJUSTABLE WRENCH
A5200-0516	ADJUSTABLE WRENCH END PIECE
A5200-0517	ALUMINUM BOX



PEDIATRIC ILIZAROV CIRCULAR EXTERNAL FIXATOR INSTRUMENT SET

A5200-0600	PEDIATRIC ILIZAROV CIRCULAR EXTERNAL FIXATOR INSTRUMENT SET
A5200-0601	HYBRID EXTERNAL FIXATOR (FOR ADAPTATION TO EXTERNAL CIRCULAR FIXATION SYSTEM)
A5200-0602	T-WRENCH
A5200-0603	WRENCH WITH OPEN-CIRCULAR ENDS
A5200-0604	HEXAGONAL WRENCH
A5200-0605	WRENCH WITH TWO OPEN ENDS
A5200-0606	OSTEOTOME
A5200-0607	WIRE CUTTER
A5200-0608	DOUBLE ENDED OFFSET SOCKET 7100-0020-009 WRENCH
A5200-0609	WIRE TENSIONER
A5200-0610	WIRE TIGHTENER
A5200-0611	SLEEVE GUIDE
A5200-0612	WIRE TENSIONER
A5200-0613	DRILL GUIDE
A5200-0614	DRILL GUIDE WITHOUT HANDLE
A5200-0615	ADJUSTABLE WRENCH
A5200-0616	ADJUSTABLE WRENCH END PIECE
A5200-0617	ALUMINUM BOX

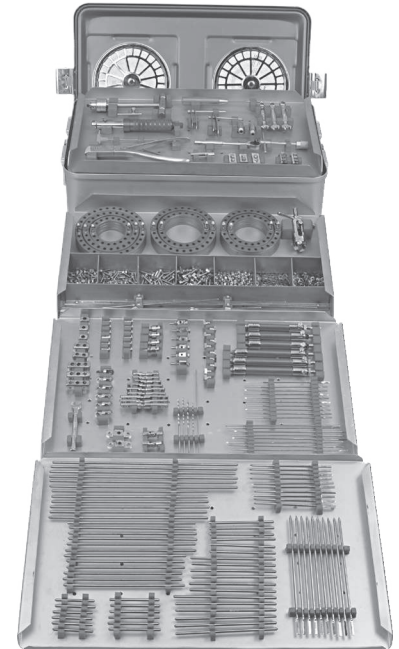

ORTHOPAEDIC SURGERY INSTRUMENT SETS

3,0/3,5/4,0/5,0/6,5 MM HEADLESS COMPRESSION SCREW INSTRUMENT SET

A4200-1200

3,0/3,5/4,0/5,0/6,5 MM HEADLESS COMPRESSION SCREW INSTRUMENT SET

- A4200-1201 Ø0,8 MM SINGLE TROCAR GUIDE WIRE
- A4200-1202 Ø1,0 MM SINGLE TROCAR GUIDE WIRE
- A4200-1203 Ø1,5 MM SINGLE TROCAR GUIDE WIRE
- A4200-1204 Ø2,0 MM SINGLE TROCAR GUIDE WIRE
- A4200-1205 Ø2,0MM THREADED TROCAR GUIDE WIRE
- A4200-1206 Ø2,0 MM CANNULATED DRILL BIT
- A4200-1207 Ø2,6 MM CANNULATED DRILL BIT
- A4200-1208 Ø3,4 MM CANNULATED DRILL BIT
- A4200-1209 Ø4,5 MM CANNULATED DRILL BIT
- A4200-1210 CANNULATED PROFIL DRILL FOR Ø3,0 MM SCREW
- A4200-1211 CANNULATED PROFIL DRILL FOR Ø3,5 MM SCREW
- A4200-1212 CANNULATED PROFIL DRILL FOR Ø4,0 MM SCREW
- A4200-1213 CANNULATED PROFIL DRILL FOR Ø5,0 MM SCREW
- A4200-1214 CANNULATED PROFIL DRILL FOR Ø6,5 MM SCREW
- A4200-1215 CANNULATED HEXAGONAL QUICK COUPLING SW 1,5 MM
- A4200-1216 CANNULATED HEXAGONAL QUICK COUPLING SW 2,0 MM
- A4200-1217 CANNULATED HEXAGONAL QUICK COUPLING SW 2,5 MM
- A4200-1218 CANNULATED HEXAGONAL QUICK COUPLING SW 3,0 MM
- A4200-1219 CANNULATED HEXAGONAL QUICK COUPLING SW 3,5 MM
- A4200-1220 HEXAGONAL QUICK COUPLING SW 1,5 MM
- A4200-1221 HEXAGONAL QUICK COUPLING SW 2,0 MM
- A4200-1222 HEXAGONAL QUICK COUPLING SW 2,5 MM
- A4200-1223 HEXAGONAL QUICK COUPLING SW 3,0 MM
- A4200-1224 HEXAGONAL QUICK COUPLING SW 3,5 MM
- A4200-1225 PARALEL WIRE GUIDE 3,0-3,5-4,0 MM
- A4200-1226 PARALEL WIRE GUIDE 5,0-6,5 MM
- A4200-1227 SCREW FORCEPS
- A4200-1228 MEASURING DEVICE 3,0-3,5-4,0 MM
- A4200-1229 MEASURING DEVICE 5,0-6,5 MM
- A4200-1230 T-HANDLE WITH QUICK COUPLING
- A4200-1231 I-HANDLE WITH QUICK COUPLING
- A4200-1232 SHARP HOOK
- A4200-1233 MINI BOX
- A4200-1234 ALUMINIUM BOX

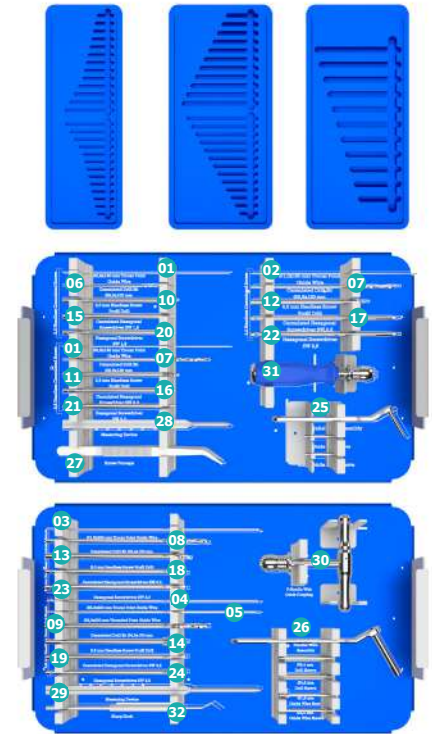

3,0/3,5/4,0 MM HEADLESS COMPRESSION SCREW INSTRUMENT SET

A4201-1200

3,0/3,5/4,0 MM HEADLESS COMPRESSION SCREW INSTRUMENT SET

- A4201-1201 Ø0,8 MM SINGLE TROCAR GUIDE WIRE
- A4201-1202 Ø1,0 MM SINGLE TROCAR GUIDE WIRE
- A4201-1206 Ø2,0 MM CANNULATED DRILL BIT
- A4201-1207 Ø2,6 MM CANNULATED DRILL BIT
- A4201-1210 CANNULATED PROFIL DRILL FOR Ø3,0 MM SCREW
- A4201-1211 CANNULATED PROFIL DRILL FOR Ø3,5 MM SCREW
- A4201-1212 CANNULATED PROFIL DRILL FOR Ø4,0 MM SCREW
- A4201-1215 CANNULATED HEXAGONAL QUICK COUPLING SW 1,5 MM
- A4201-1216 CANNULATED HEXAGONAL QUICK COUPLING SW 2,0 MM
- A4201-1217 CANNULATED HEXAGONAL QUICK COUPLING SW 2,5 MM
- A4201-1220 HEXAGONAL QUICK COUPLING SW 1,5 MM
- A4201-1221 HEXAGONAL QUICK COUPLING SW 2,0 MM
- A4201-1222 HEXAGONAL QUICK COUPLING SW 2,5 MM
- A4201-1234 PROFIL DRILL SLEEVE FOR 3,0/3,5/4,0 MM PROFIL DRILL
- A4201-1235 DRILL&WIRE SLEEVE FOR 2,0/2,7 DRILL /0,8/1,0 WIIRE
- A4201-1227 SCREW FORCEPS
- A4201-1228 MEASURING DEVICE 3,0-3,5-4,0 MM
- A4201-1231 I-HANDLE WITH QUICK COUPLING
- A4201-1237 MINI BOX
- A4201-1238 ALUMINIUM BOX

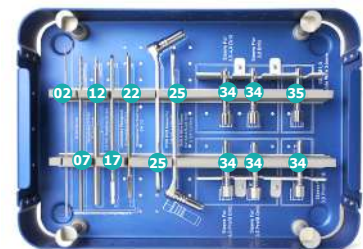
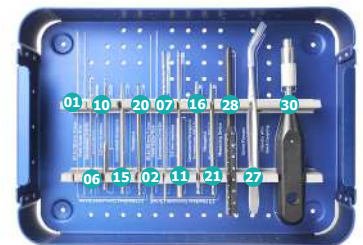

5,0/6,5 MM HEADLESS COMPRESSION SCREW INSTRUMENT SET

A4202-1200

5,0/6,5 MM HEADLESS COMPRESSION SCREW INSTRUMENT SET

A4202-1203	Ø1,5MM SINGLE TROCAR GUIDE WIRE
A4202-1204	Ø2,0 MM SINGLE TROCAR GUIDE WIRE
A4202-1205	Ø2,0 MM THREADED TROCAR GUIDE WIRE
A4202-1208	Ø3,4 MM CANNULATED DRILL BIT
A4202-1209	Ø4,5 MM CANNULATED DRILL BIT
A4202-1213	CANNULATED PROFIL DRILL FOR Ø5,0 MM SCREW
A4202-1214	CANNULATED PROFIL DRILL FOR Ø6,5 MM SCREW
A4202-1218	CANNULATED HEXAGONAL QUICK COUPLING SW 3,0 MM
A4202-1219	CANNULATED HEXAGONAL QUICK COUPLING SW 3,5 MM
A4202-1220	HEXAGONAL QUICK COUPLING SW 1,5 MM
A4202-1223	HEXAGONAL QUICK COUPLING SW 3,0 MM
A4202-1224	HEXAGONAL QUICK COUPLING SW 3,5 MM
A4202-1226	PARALEL WIRE GUIDE 5,0-6,5 MM
A4202-1227	SCREW FORCEPS
A4202-1229	MEASURING DEVICE 5,0-6,5 MM
A4202-1230	T-HANDLE WITH QUICK COUPLING
A4202-1232	SHARP HOOK
A4202-1235	MINI BOX
A4202-1236	ALUMINIUM BOX

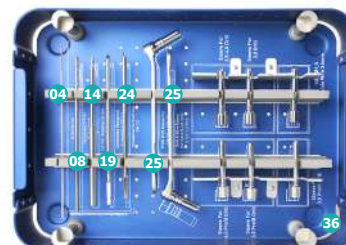
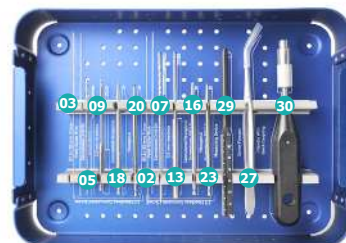

CABLE INSTRUMENT SET

A4200-1700

CABLE INSTRUMENT SET

A4200-1701	CABLE PASSER-CURVED
A4200-1702	CABLE PASSER
A4200-1703	PROVISIONAL TENSIONING DEVICES
A4200-1704	CABLE CRIMPER
A4200-1705	CABLE CUTTER
A4200-1706	ALUMINIUM BOX

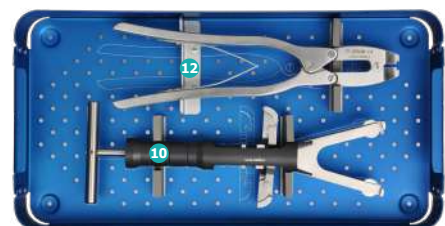
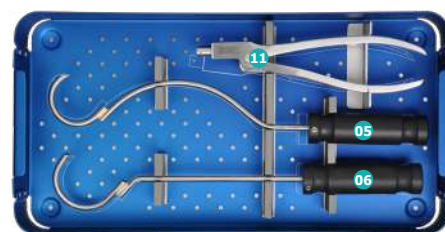



AYSAM | Samsun

Organize Sanayi Sitesi Erdoğan Cebeci Bulvarı No. 34
Kutlukent Tekkeköy, 55330 SAMSUN/TÜRKİYE

AYSAM | İstanbul

Molla Gürani Mah. Molla Gürani Cad. No:59/9
Fındıkzade/Fatih İSTANBUL/TURKEY



AYSAM | Warehouse

Kirazlık Mah 1034 Cd. No:14 Tekkeköy
SAMSUN/TÜRKİYE



Manufacturer of Orthopaedics & Medical Devices
quality & trust

